

JULY, 1935

RADIO RETAILING

INCLUDING
SERVICE
AND
INSTALLATION
SECTION

HOME ENTERTAINMENT MERCHANDISING

THE GREATEST RADIO TUBE ADVANCE IN 28 YEARS

ALL-METAL RADIO TUBES

Sponsored by Two Great Names—Designed by  Made by 

22 LEADING RADIO MANUFACTURERS HAVE ALREADY ADOPTED RCA METAL TUBES AS STANDARD EQUIPMENT

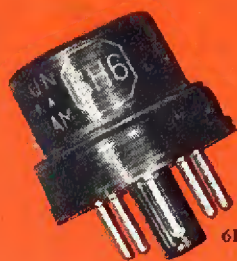

6H6—The new AVC tube



6C5—Triode Detector-Amplifier



6L7—Pentagrid Mixer-Amplifier



6K7—Triple-Grid Variable-Mu Amplifier

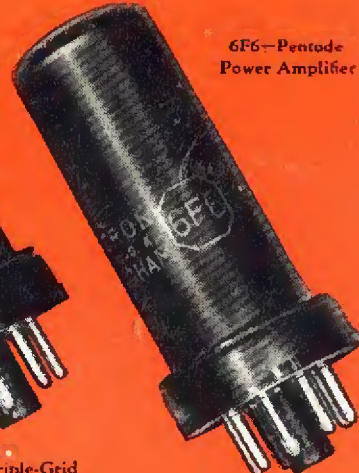

6F6—Pentode Power Amplifier

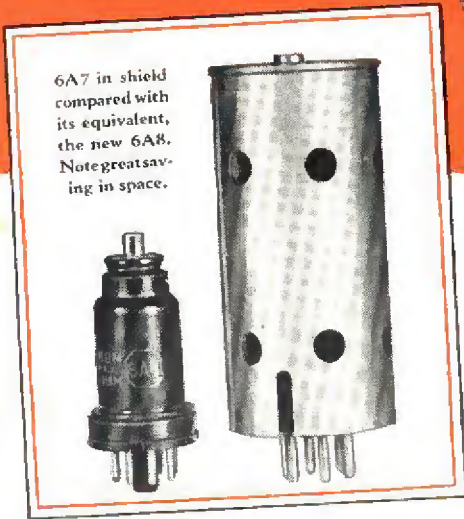

6A7 in shield compared with its equivalent, the new 6A8. Note great saving in space.

Recent great advances in electrically controlled welding and new metal alloys make this achievement possible

A Few of the Exclusive Advantages and Selling Features:

1. All metal construction.
2. Extreme quietness due to all metal.
3. Compactness, resulting in improved engineering design.
4. Self-shielding.
5. Uniform shielding.
6. Better short-wave performance, due to perfect shielding.
7. New Octal base, with self-aligning plug and key.
8. Electrically-welded and mechanically-locked base.
9. Rugged mount, supported by 7 or more wires leading directly to base pins.
10. Designed by G. E., made to new high precision standards by RCA.

Cash in on the tremendous publicity and advertising that will be given to RCA Metal Tubes. Feature 1936 Radio Sets equipped with RCA Metal Tubes.

RCA RADIO TUBES

RCA RADIOTRON DIVISION, RCA MANUFACTURING CO., INC., CAMDEN, NEW JERSEY

Of Course!

THE NEW STEWART-WARNER RADIOS WILL HAVE METAL TUBES



And Here Are 6 Facts About Metal Tubes That Every Dealer Should Know!

1. Metal tubes mark a new, practical, logical advance in radio manufacture and include perfected performance features that the public will quickly grasp and demand.
2. To perfect the use of metal tubes—to refine and develop every performance advantage—Stewart-Warner has designed the new and exclusive Stewart-Warner *Ferrodyne* Chassis.
3. Stewart-Warner has accepted the metal tube *without compromise*. The Stewart-Warner *Ferrodyne* Chassis has been developed, *from the ground up*, to include metal tubes, and is not to be confused with any last-minute "makeshifts" that may be offered.
4. The greatest manufacturers—the greatest scientific

groups in radio—*others as well as Stewart-Warner*, have recognized the tremendous advantages of the metal tube and are backing it with every resource.

5. With the big bulk of advertising and sales efforts to back them, radio sets featuring metal tubes will represent the major portion of your sales in the 1935-1936 season. *The new Stewart-Warner line with metal tubes in the exclusive Stewart-Warner Ferrodyne Chassis will create active store traffic and build steady profits for you.*

6. If you want to get in on the ground floor—really "cash in" in a big way with a line that is going places and *will bring you with it*—watch for the announcement of the new Stewart-Warner line—then get complete information. Phone, wire or write.

STEWART-WARNER CORPORATION
1853 Diversey Parkway Chicago, Illinois

STEWART-WARNER

Round-the-World RADIO

RADIO RETAILING, July, 1935, Vol. 20, No. 7. Published monthly, price 25c. copy. Subscription rates—United States and Central and South American countries, \$2.00 a year. Canada, including duty, \$2.50 a year. All other countries \$3.00 a year or 12 billings. Entered as second-class matter April 10, 1924, at Post Office at New York, N. Y., under the Act of March 3rd, 1879. Printed in U. S. A. Cable address "McGraw-Hill, New York." Member of A.B.P. Member of A.B.C. Copyright 1935 by McGraw-Hill Publishing Co., Inc., 320 West 42d Street, New York, N. Y.

Printed by The Schenker Press, N. Y.



MODEL 4-T-51—Superheterodyne with triple filtering. 3 inch dynamic speaker. Tuning range from 510 to 3,000 K.C. Black dial. An especially smart example of modern console design. 35 inches high.

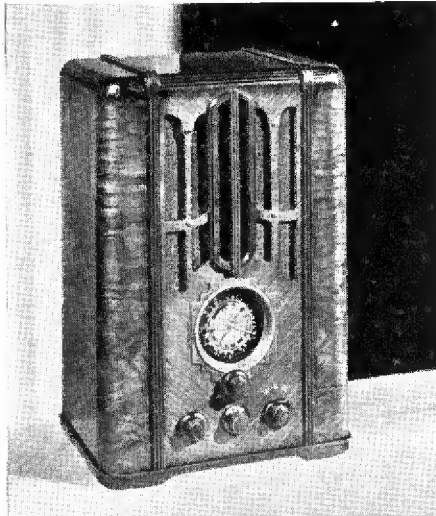

MODEL 5-S-29—5 tube Superheterodyne, triple filtering. 6 inch dynamic speaker. Tuning range from 535 to 18,500 K.C. Split-second tuning. In a design that makes the most of rounded corners, this table model reveals a compactness that may be achieved through a restrained use of decoration. 18 inches high.

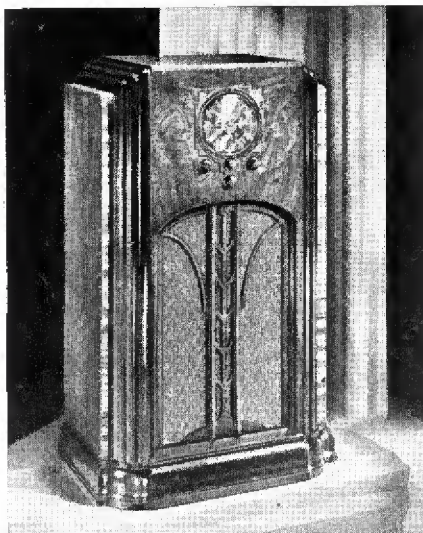

MODEL 9-S-55—9 tube Superheterodyne, triple filtering. 12 inch auditorium dynamic speaker. 5 wave bands on 3 simplified dial ranges—550 to 23,000 K.C. 6 inch black dial, bands individually illuminated in colors; split-second tuning—overtone amplifier. This console model combines rare woods in a masterly manner. 42 inches high.

The New and Distinguished



1936 LINE



Now Ready for the Market!

Here, perhaps, is the most important announcement of the year to the radio world. A new, exceptional and far superior line of Zeniths is now ready—ready for you to display, ready for you to sell with amazing ease. And—ready to help you win the easiest, best and most generous profits in your business history!



Zenith Now Features

- ★ THE BLACK DIAL
- ★ SPLIT-SECOND TUNING
- ★ OVERTONE AMPLIFIER
- ★ TRIPLE FILTERING
- ★ DIMENSIONAL TONE

All Zeniths Designed for Metal Tubes



ZENITH RADIO CORPORATION
3620 Iron Street, Chicago, Ill.



Hot Numbers
for **SUMMER SALES!**

No. 58-T Triple-Range World-Wave (height, 19 inches) **\$59.50**

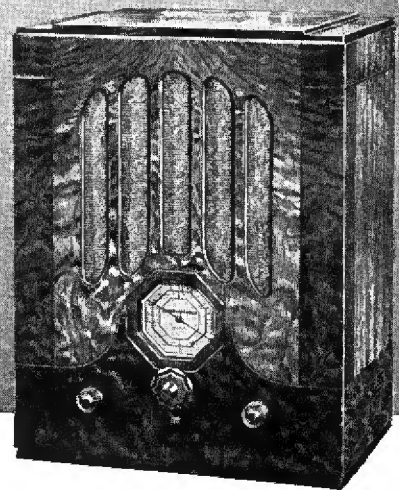

That's what dealers and dealers' salesmen are saying everywhere. More people coming into the stores. Sales of radio actually increasing right in mid-summer.

It's because these first numbers of the Stromberg-Carlson Fall line — three World-Wave Radios all under \$100 — are the greatest values in the radio market today. World-ranging, they cover all the regular international short wave broadcasts—the police bands—aircraft, amateur and the high fidelity channels.

These summer-selling Stromberg-Carlsons; other models coming, equally startling in value—a complete showing in every price class (\$59.50 to \$985, Texas, Rockies and West slightly higher) — all this opens up profit possibilities for dealers not to be found in any other line.

Write for details of franchise.

STROMBERG-CARLSON TELEPHONE MFG. CO., ROCHESTER, N. Y.

"A LIFE SAVER" Says this Merchant
(Excerpt from letter to Stromberg-Carlson Company)

"Your letter (telling of the line) holds the most promise for me in the future of my radio business that has come along in 8 years. Your announcement of a competitive line over the longest price range in the industry sounds like a life saver to a dealer in towns of this size . . . I look forward to a big season with Stromberg-Carlson."

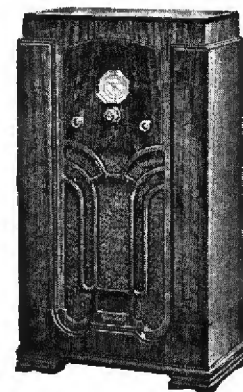

**Triple-Range
World-Wave
No. 58-L**
Height, 36½ inches
\$78.50

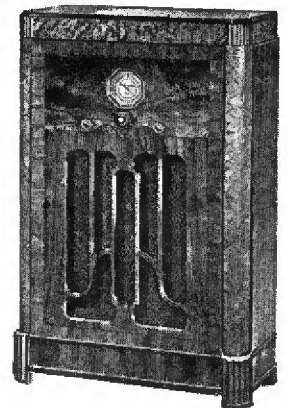

**Triple-Range
World-Wave
No. 58-W**
Height, 37¼ inches
\$92.50

Stromberg-Carlson

● THOUSANDS WILL
SOON BE SAYING:

*"That's the Best Radio for the Money
I've Ever Heard - Who Makes it?"*

IT'S ONE OF THE NEW

ARVINS

BY THE MAKERS OF THAT
MAGNIFICENT CAR RADIO

● It's only natural that Arvin should now enter the field of radio for the home. Arvin radio engineering and marketing ability has been proved. Arvin success with car radio is the talk of the industry. And next month, Arvin will announce a magnificent line of home sets, with everything most people want and can afford to buy — radios with thoroughly fine performance and appearance, priced moderately for volume sales—plus the good, dependable Arvin trade policies.

NOBLITT-SPARKS INDUSTRIES, Inc., Columbus, Ind.

WATCH FOR ANNOUNCEMENT OF THE NEW
ARVIN HOME RADIO LINE NEXT MONTH



The NEW -- 1936 Emerson

with the New METAL TUBES

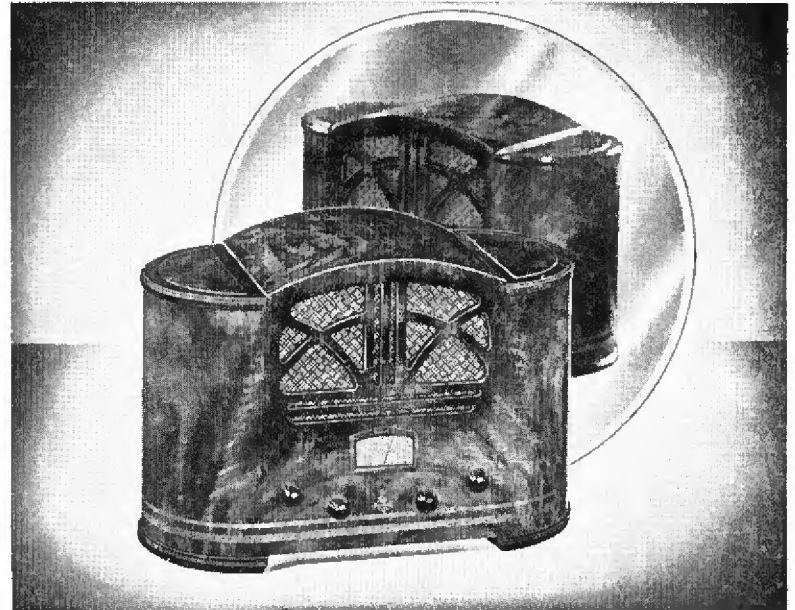

Emerson "Duo-Vox" AC-DC Model 107
6-Tube Three-Band—Incorporating METAL TUBES—American and Foreign Receiver. Sensational new type—containing front and back design. Three-band. Automatic Volume Control, Tone Control, Color-matched Illuminated Dial, Shock-mounted Variable Condenser, Telegraphic Interference Trap, Capacitive Filter, Dust-proof Dynamic Speaker and other advance features. Cabinet of hand-rubbed matched American Butt Walnut with mahogany inlay, 10 1/2 in. high. Listed by Fire Underwriters' Laboratories. List price with R.C.A. tubes

\$ 44.95

**"Re-Creates the Artist
in Your Home"**

A Revolutionary Advance in Radio Construction. Makes Every Emerson Radio a Laboratory Model.

Emerson "HARMONIZED UNIT" Radio is radio with every vital and critical unit of the set especially designed and brought into harmonious relationship with all other parts of the receiver. It is *pre-built* in accordance with the principle that no chain is stronger than its weakest link. If the individual units are right, the completed set **MUST** be right. Then the broadcast impulses flow uninterrupted through the perfect circuit. Artificial, metallic sounds give way to true voice and instrument modulations.

Emerson "HARMONIZED UNIT" Radio, like a high-precision timepiece is a sub-assembled group of *pre-constructed* units. Each is tested and proved-in-advance, each is open to visual chassis inspection and each combines with the others to produce a perfect replica of the laboratory model.

NOTE: Prices slightly higher in West and South. Full distributor and dealer details now available.

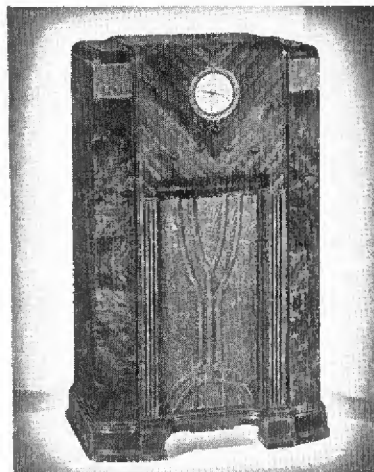

HIGH FIDELITY . . . Model 105
American and Foreign Receiver
 Complete Wave Band—16 to 550 meters. 11-tube AC Superheterodyne using 10 METAL TUBES. "Micro-Selector." Auditorium speaker, 15-watt output. De Luxe Walnut cabinet. List price complete

\$129.95



COMPLETE WAVE BAND
 —16 to 550 Meters . . . Model 102
American and Foreign Receiver
 8-tube AC Superheterodyne, 6 METAL TUBES. "Micro-Selector." 7-watt output. Walnut cabinet. List price complete

\$89.95

Radio

Distributors—Dealers—write, wire or telephone for details of the complete Emerson line and sales proposition. Everything which favors successful operation is present in Emerson's 1936 merchandising plans. Powerful advertising—field cooperation—liberal policies.



Emerson "Duo-Vox" . . . AC-DC Model 106 6-Tube Two-Band—Incorporating METAL TUBES

Front and back facing identical. Broadcast band and complete police band. Automatic Volume Control, Tone Control, Shock-mounted Variable Condenser, Telegraphic Interference Trap, Capacitive Filter, sliding horizontal Illuminated Dial, dust-proof Dynamic Speaker. Cabinet of hand-rubbed matched American Butt Walnut with mahogany inlay. 8 3/4 in. high. Listed by Fire Underwriters' Laboratories. List price with R.C.A. tubes . . .

\$34.95

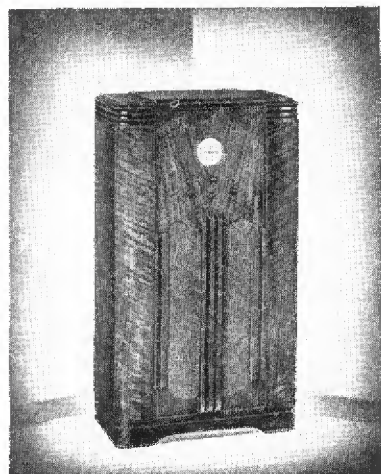

THREE-BAND . . . Model 101 American and Foreign Receiver

6-tube three-band AC Superheterodyne. Color-matched tuning. Dynamic speaker. Walnut cabinet. List price with tubes . . . **\$59.95**

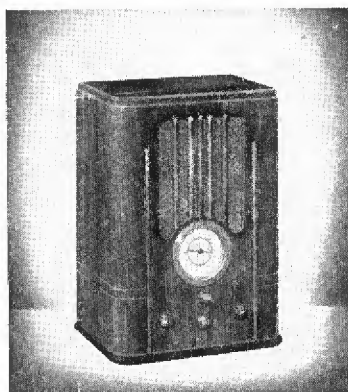

THREE-BAND . . . Model 34-C American and Foreign Receiver

6-tube AC Superheterodyne employing 4 Metal Tubes. 3 wave bands. Aeroplane dial—color-matched tuning. Walnut cabinet 16-in. high. List price with R.C.A. tubes . . . **\$44.95**

19 MODELS

\$14.95 to \$129.95

The complete Emerson line embraces EVERY type of modern radio—a model for every purse.

AC TABLE MODELS	
5-tube Two-Band Superheterodyne	\$19.95
6-tube Three-Band Superheterodyne	44.95
8-tube Three-Band Superheterodyne	69.95

AC-DC COMPACTS	
4-tube Superheterodyne	\$14.95
5-tube Two-Band Superheterodyne	24.95
5-tube Two-Band Superheterodyne	29.95
6-tube Two-Band Superheterodyne	34.95
6-tube Three-Band Superheterodyne	39.95
6-tube Three-Band Superheterodyne	44.95

CONSOLES	
6-tube AC Three-Band	59.95
6-tube AC-DC Three-Band	\$69.95
8-tube AC Four-Band Superheterodyne	89.95
11-tube AC HIGH FIDELITY Four-Band Superheterodyne	109.95

BATTERY SETS	
5-tube and Ballast Lamp—Two-Band	\$34.95
(Two 7-tube sets—1 compact, 1 console—to be announced.)	

AUTO RADIO	
3 models	\$37.95, \$44.95, \$49.95



NOTE:

Battery Radio
cabinet models 101 and 34-C are used to house two of the three new Emerson Battery sets. Details on request.

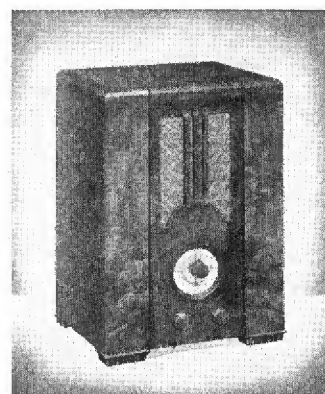

DUAL-WAVE . . . Model 36
5-tube AC Superheterodyne. 95-550 meters. 3-watt output. Dynamic speaker. Illuminated dial. Many exclusive features. List price with R.C.A. tubes . . . **\$19.95**

The most spectacular news

ATWATER KENT



MODEL 328

FAMOUS *Atwater Kent* quality workmanship has again improved every new set from the small 4-tube Compact to the de luxe 12-tube Console. New *Atwater Kent* cabinet designs are of distinguished and practical beauty. *Atwater Kent* specially designed circuits get the utmost out of the new METAL TUBES.

Here is a line right down the alley of every wide-awake dealer—in its sensible variety of models, in price range and in every proved improvement that makes a radio sell and keep on selling.

ATWATER KENT MFG. CO. A. *Atwater Kent*, Pres. PHILADELPHIA, PA.

A NEW TONE REALISM. In the studio Control-Rooms of broadcasting stations radio reception is at its best. Here it *must* be perfect. That's the job of the Control-Room engineer, to make it perfect and send out on the air every wisp of sound and every voice inflection just as it is right in the studio. How it is received depends on the radio set. ATWATER KENT for 1936 brings this perfect reception right into the home. It is radio with a new tone realism—radio with **CONTROL-ROOM RECEPTION.**

MODEL 328 (Above left) An 8 METAL-tube console. Standard and short-wave shadow tuning from 540 to 18,000 K.C. 9 tuned circuits. 4-position tone control. Full tone quality or sharpened selectivity with the new Selectivity-Fidelity switch. Full vision dial. \$99.75 f. o. b. factory. **MODEL 649** In the same cabinet as Model 328 there is a powerful 9 METAL-tube receiver at \$115.00 f. o. b. factory.

MODEL 976 (Below, extreme left) 6 METAL tubes in this unusual new roll top design console give greatly improved tone quality to this new long and short-wave model. 3-range tuning from 540 to 18,000 K.C. 7 tuned circuits. 3-position tone control. Here's superb performance and remarkable value at \$75.50 f. o. b. factory.

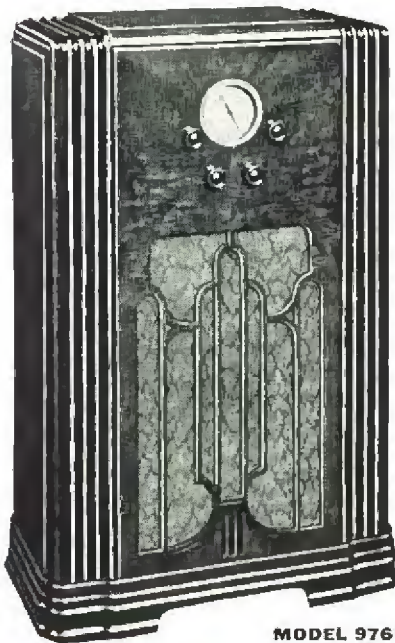

MODEL 976

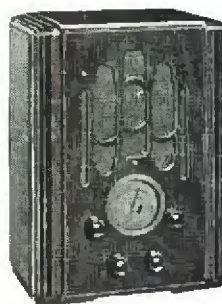

MODEL 856 A 6 METAL-tube compact, 3-range tuning from 540 to 18,000 K. C. 7 tuned circuits. 3-gang condensers. Accurate 2-speed tuning. Dial illuminating only band in use. Improved selectivity and full tone quality. Distinctive cabinet. \$56.50 f. o. b. factory.

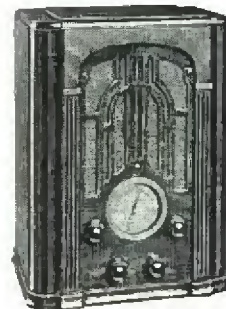

MODEL 337 A compact with 7 METAL tubes, 3-range tuning from 540 to 18,000 K.C. 7 tuned circuits. 3-gang condenser. 2-speed tuning. Automatic hand selecting illuminated dial. Rich in tone and truly selective. A remarkable set for \$64.50 f. o. b. factory.



MODEL 184 A 4-tube compact. Tuning range from 540 to 1712 K.C. 4 tuned circuits, 2-gang condenser. Illuminated dial. Vernier tuning. Rich tone quality from fully proportioned dynamic speaker. A smart little set at the moderate price of \$27.50 f. o. b. factory.

WITH A NEW TONE REALISM

of the Coming Season!...

Metal Tube RADIO

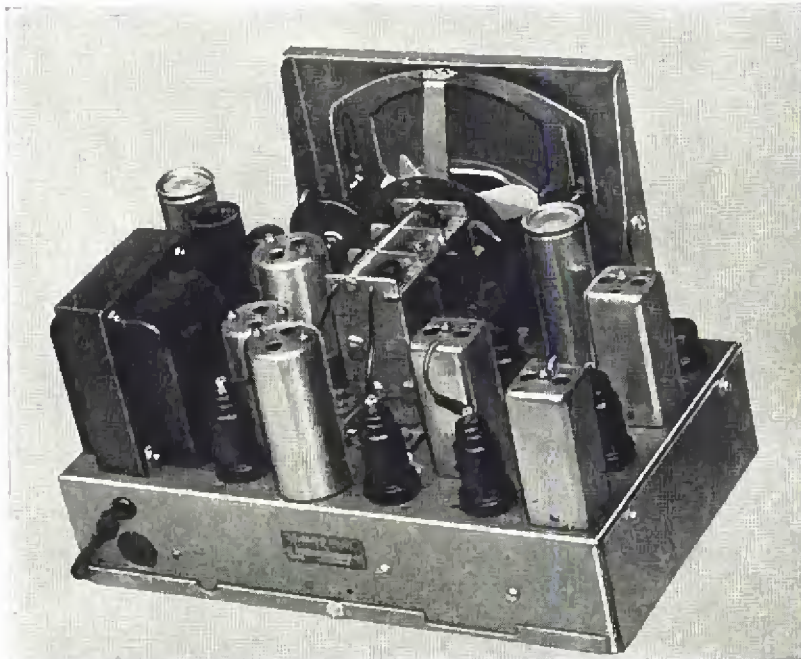

All of the METAL TUBE receivers in the new 1936 line, including this nine-tube chassis have been specifically designed by ATWATER KENT for the new METAL TUBES. Again ATWATER KENT engineering keeps pace with every proved improvement.

MODEL 317 (Above, right) Superb performance in domestic and foreign reception. 7 METAL tubes. 3 tuning ranges. 7 tuned circuits. Illuminated range selecting dial. Excellent tone quality. One of the smartest console cabinets ATWATER KENT ever designed. **\$87.50** f.o.b. factory.

MODEL 810 (Extreme right) ATWATER KENT presents this 10-tube console with new METAL tubes as one of the finest receivers they have ever produced. 4 tuning ranges from 540 to 18,000 K.C. 9 tuned circuits. 4-position tone control. Selectivity-Fidelity switch. 11 in. dynamic speaker presents "Control-Room Reception." Full vision dial, and shadow tuning. **\$150.00** f.o.b. factory. **MODEL 412** For those who want the utmost in radio there is a 12-tube receiver with new METAL tubes housed in the same luxuriant modern cabinet as Model 810. Its price is **\$180.00** f.o.b. factory.

MODEL 435 (At right) An interesting "lowboy" 6-tube console model with new METAL tubes. 2 tuning ranges from 510 to 1712 and 2300 to 7500 K.C. 6 tuned circuits. 3-position tone control. Rich full tone and excellent sensitivity. **\$58.50** f.o.b. factory.

Battery operated receivers, sets for 32-volt power, sets for Export, Motor Car Radio, and the famous ATWATER KENT Tune-O-Matic complete the 1936 Models—the surest-fire line in performance, appearance and price range ever offered any radio dealer.

Prices subject to change without notice

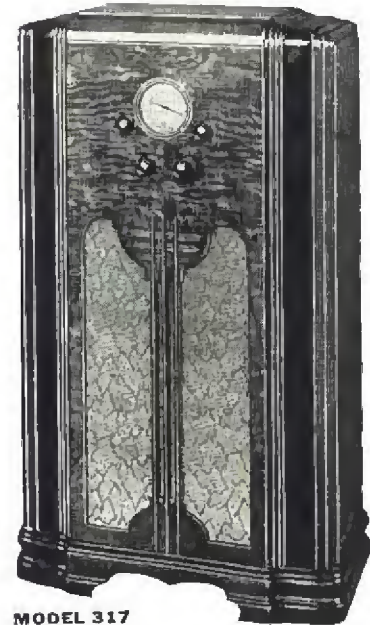

MODEL 317



MODEL 435



MODEL 810

CONTROL-ROOM RECEPTION

▶ FADA FORGES AHEAD ◀

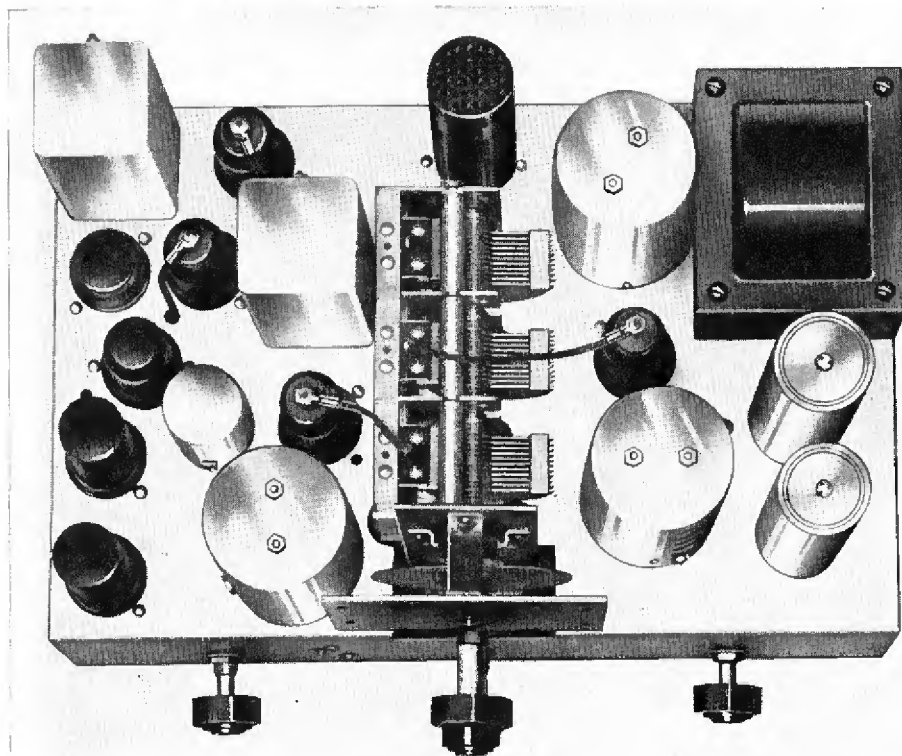

INTRODUCING
a wide range of
1936 models with

**ALL-
METAL
TUBE
CHASSIS!**

AGAIN **FADA** gives to the world an outstanding achievement in radio . . . and marks a new era in radio engineering, **THE ERA OF ALL-METAL TUBES.**

FADA gave to the world **THE FIRST PRACTICAL BATTERY SET** with a **NEUTRODYNE CIRCUIT** . . . for the first time tuning became possible to any member of the household. FADA produced **THE FIRST PRACTICAL CONE SPEAKER** and lifted the receiver from a signal novelty to **THE WORLD'S NEWEST MUSICAL INSTRUMENT!** FADA again set the pace with **THE FIRST PRACTICAL ELECTRIC SET** with the **227 HEATER TYPE TUBE** and **THE FIRST HI-FIDELITY DYNAMIC SPEAKER.**

And now FADA, preserving all its acknowledged features of superiority . . . a superiority attested by over 1,200,000 FADA owners . . . adds the new feature of **ALL-METAL TUBES.** With richer tonal quality and wider range than ever before, FADA again forges ahead with the finest receiver of this newest era, **THE ERA OF ALL-METAL TUBES.**

FADA offers a radio for every purse . . . from compact to **HI-FIDELITY** console . . . straight AC and AC-DC **WORLD-WIDE** receivers . . . from \$19.99 to \$144.50. Write for Distributor or Dealer proposition.

FADA Radio

FADA RADIO & ELECTRIC COMPANY •

Long Island City, N. Y.

1920 • SINCE BROADCASTING BEGAN • **1935**



Coming July 29th

... a secret radio development by
AMERICAN-BOSCH

On July 29th, American-Bosch will announce something entirely new and different in radio.

Its effect on improving radio performance is even more sensational and revolutionary than metal tubes alone, which of course are properly engineered into the 1936 American-Bosch Radio.

May we assure the radio trade that this is no mere extravagant claim, but a definite dramatic advance in radio that you and your customers can —

*Mail this coupon
for full information*



SEE



TOUCH



HEAR

UNITED AMERICAN BOSCH CORPORATION, Springfield, Massachusetts

Send me immediately upon release July 29th, full information about the sensational and revolutionary new American-Bosch development in radio for 1936.

Name..... Street Address..... City and State.....

RADIO RETAILING

Vol. 20

No. 7

CONTENTS, JULY, 1935

Copyright, 1935, by McGraw-Hill Publishing Company, Inc.

<i>Backtrack for Business</i>	11
<i>Skywire Specialist</i>	12
<i>Managing Manpower</i>	14
<i>Community Demonstration</i>	16
<i>A Serviceman Cold Canvasses</i>	18
<i>Sales Shorts</i>	20
<i>What They're Advertising</i>	24
<i>Shortwave DX'ing Aid</i>	26
<i>Tube Sales Ideas</i>	27
<i>News of the Month</i>	28
<i>New Antenna Equipment</i>	43
<i>Other New Merchandise</i>	46

SERVICE SECTION

<i>Circuits of the Month</i>	59
<i>Modern Double Downlead Antennas</i>	61
<i>Practical Hints on Antenna Installation</i>	67
<i>Shop Shortcuts</i>	67
<i>Tricks of the Trade</i>	69

A NEW ERA IN THE MAKING

As of July 1, a sufficient number of the new sets have been unveiled before the wondering eyes of delighted distributors—and the writer—to justify certain prophecies. It is clearly apparent that the metal tube has taken the industry by storm. It is also apparent that this little device is more than merely the old tube in a new jacket. It is developing several very valuable performance characteristics all its own and further advantages are unquestionably coming to light in the near future.

But this is not all that is happening in radio design. Talking points to enable dealers to sell a set of a certain make on its own individual merits are seen in every line. Large dials of new design, artistic pylons in front of grilles and many technical refinements will definitely outdate all prior models.

Radio is entering a new era. It is facing a sales boom as marked as that which started with the advent

of the a.c. tube and the dynamic speaker. It is entering an era where sets can be sold on merit regardless of trade name acceptance by the public. Only downright dumbness on the part of the dealer will stand in the way of the best profit year the industry has had since 1929.

The manufacturers are doing their part. They are supplying, early in the season, distinctive, salable merchandise. Price will no longer be a factor unless dealers make it so.

Forget price competition. Study these new models. *Nineteen thirty-six will reward able salesmanship.*

Ray V. Sutcliffe

Editor.

RADIO RETAILING

RAY V. SUTLIFFE
Editor

HOWARD EHRLICH
Vice-President

H. W. MATEER
Manager

W. W. MacDONALD
Managing Editor

O. H. CALDWELL
Consulting Editor

T. H. PURINTON
Assistant Editor

HARRY PHILLIPS
Art Director

PAUL WOOTON
Washington

JULY 1935

BACKTRACK for BUSINESS

A MAJOR handicap of the radio business has been its lack of profitable accessories. Now we have one that "has everything" . . . the modern *noise-reducing antenna*.

Some dealers have merchandised this item with good results for more than a year. (A few, such as one organization described in the following pages, have developed it into a major activity.) But in the main its sales potentialities have not yet been fully probed by the trade.

Consider these extremely favorable features:

- 1.** The majority of receivers in use are equipped with skywires that are neither efficient nor sightly. For years the importance of a good aerial was minimized in order to cut free installation costs.
- 2.** Noise-reducing antennas carry a list sufficiently large to justify modest promotion expense. They are, also, wedded to an installation fee which is important in itself.
- 3.** Such antennas have been tremendously publicized by the makers of allwave receivers. (One manufacturer talks about them nightly over the air.) The public knows about them, is already more than half convinced that they are worthwhile for any radio, allwave or otherwise.

Noise-reducing antennas will, of course, be sold with most new receivers by aggressive dealers, rendering greater consumer satisfaction and swelling the dollar value of the initial sale. And no allwave receiver should go out without one. But the greatest opportunity for profit lies in backtracking for business.

Approach old customers with this new accessory. Most of them need it. And what a perfect opportunity to survey new set needs!



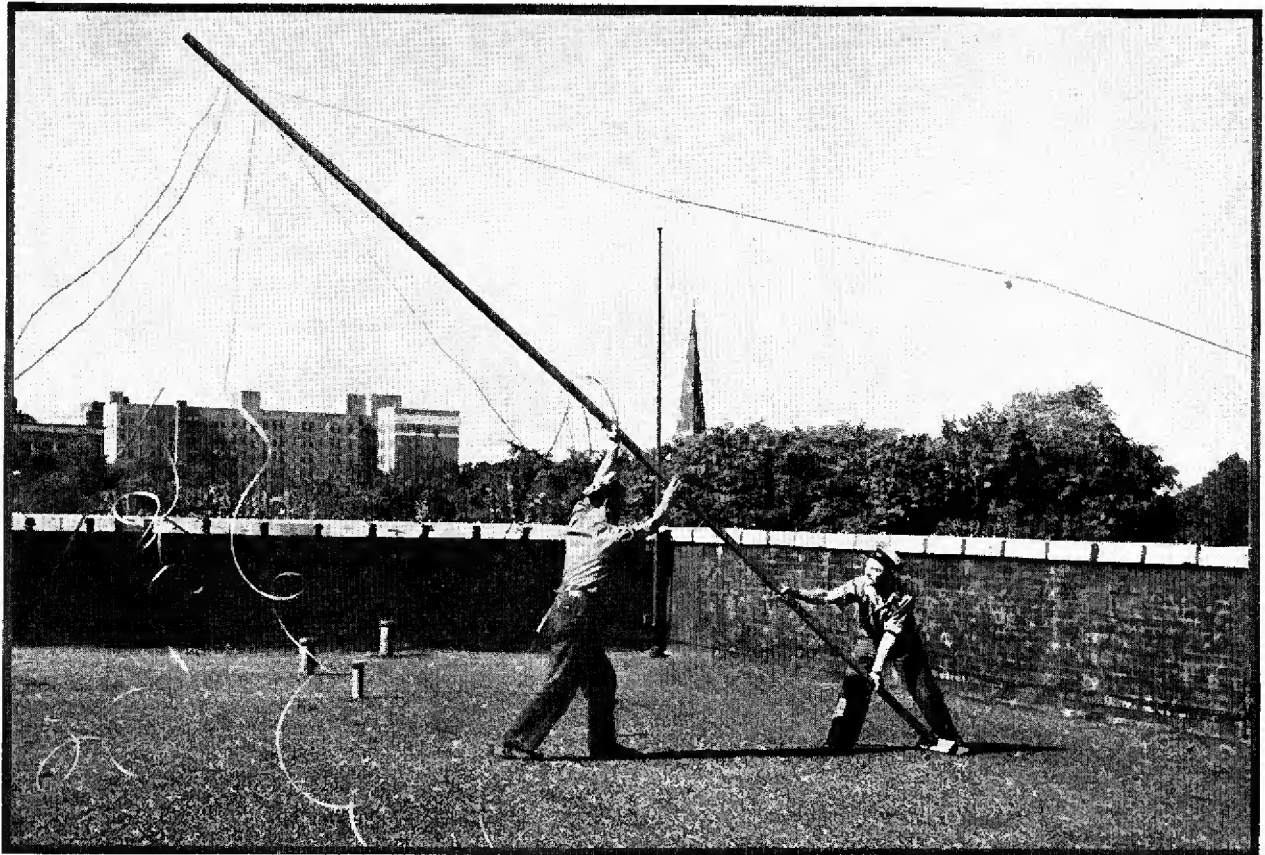

Practice makes perfect and Iroquois Aerial Service can put up the average noise-reducing antenna system in an hour

Skywire Specialist

Frank Bestine of Buffalo has installed 6,000 antennas for dealers, grosses \$5,000 annually on this business

THIS is the story of a unique business. Frank Bestine's Iroquois Aerial Service, maintaining a \$25 sidestreet store in Buffalo, doesn't sell sets and doesn't service. It concentrates on antenna installations for dealers only, grosses \$5,000 a year.

Bestine has specialized in skywires since 1927. His is no mushroom experiment. "I can show dealers that it costs little more than the bare price of materials to have me do all their work, that the installation methods of a specialist give the customer a much better job and keep sets sold. I bill the dealer, never the customer, hence the store may make a profit on the sale of special antennas," he advises. "Naturally many turn over all their installations to me."

About 6,000 antennas have been erected by Iroquois. 25 of these in stores for demonstration purposes. Bestine himself and two helpers do all the work and in the winter season we are assured that it is no work for a weakling. Here's the recommended cold-weather raiment:

- Sheepskin-lined aviator's helmet
- Sheepskin-lined leather coat with high collar
- Summer underwear
- Sweatshirt, flannel workshirt

- Two pairs of work pants
- Canvas tennis shoes, high leather shoes
- Two pairs of gloves.

All of this is worn at once, with the exception of the duplicating sets of shoes and gloves. These are changed when wet. And it is little enough when the thermometer hits zero or below and roofs are high and sleety. There is, Bestine advises, one other essential item . . . plenty of *nerve*.

The antennaman's tool kit is equally important. It consists of a 32-ft. extension ladder, 16-ft. hook ladder, pliers, hammer, screwdriver, ½-in. and ⅝-in. Star drills, each 18 in. long, and a ½-in. tube drill, 8 in. long.

WE QUERIED Frank about the effect on his business of the increasing popularity of allwave sets, discovered that 75 per cent of his volume is directly associated with new set selling. And 50 per cent of his new set installations involve the use of special noise-reducing antenna systems. The services of an experienced and competent aerial man is of even greater value when erecting such systems than when putting up the ordinary "garden variety" of flat top.

Is The Noise-Reducing Antenna Worthwhile Pushing?

Here's a man who makes his living selling and installing them. He does this, and nothing else, 12 months a year

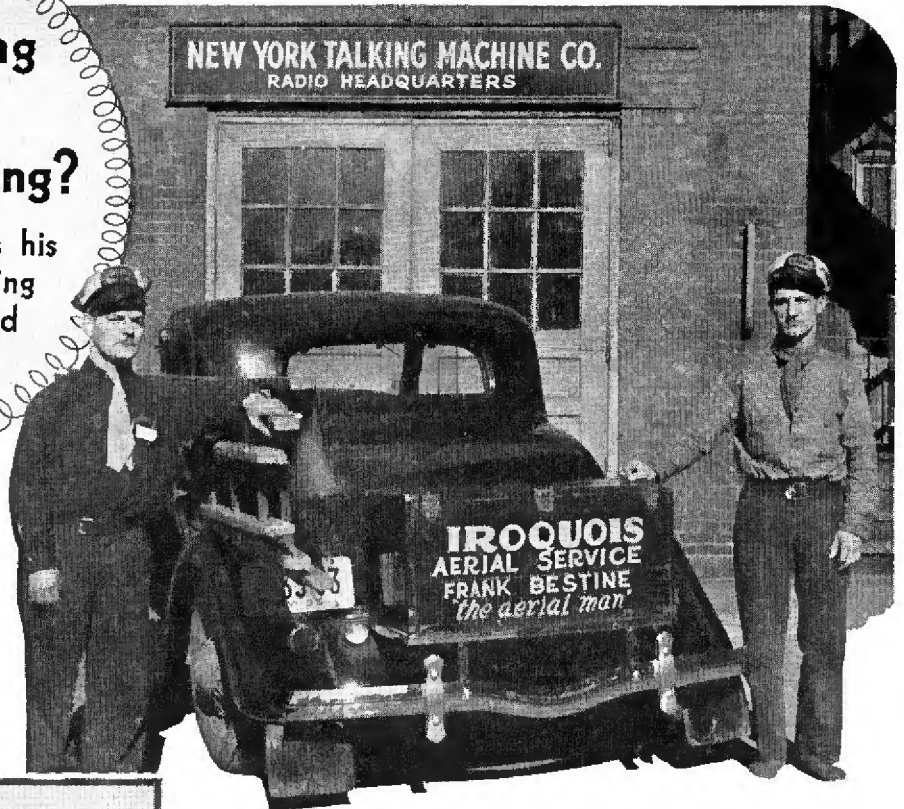

Bestine (left) and assistant Schuh carry full equipment, including a 32 ft. extension ladder and a hook ladder, on all calls

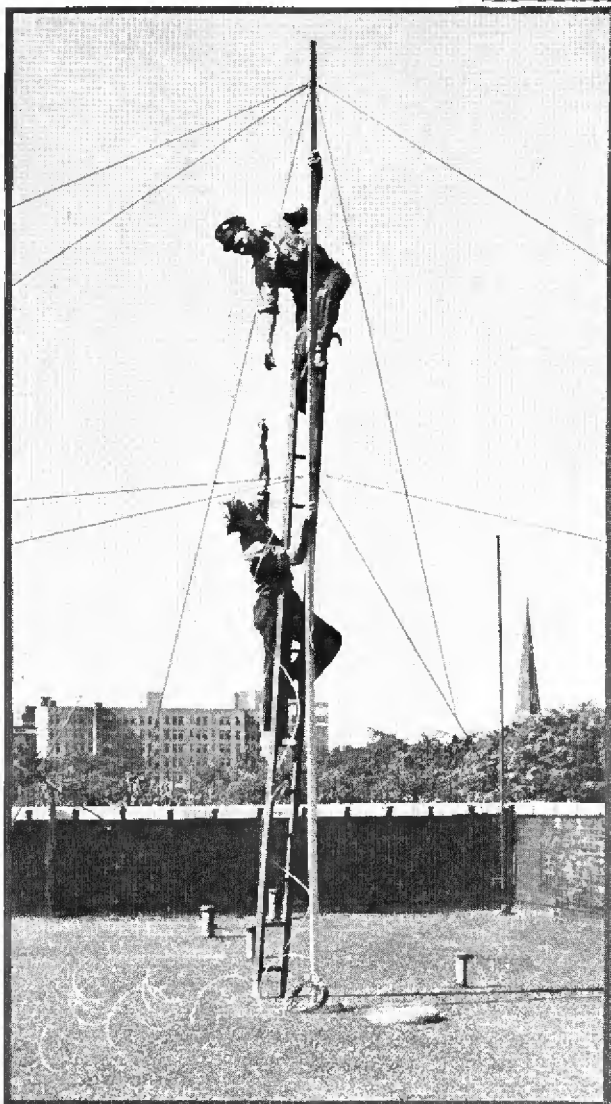

An antennaman needs experience, proper tools . . . and plenty of nerve

The remainder of Bestine's business is the replacement of old antennas with new, modern types. A number of his dealer accounts are passing along business of this kind obtained while contacting old customers for new business.

Dealers pay for work C.O.D. as a rule, collecting from the consumer when making a set sale. A few accounts are billed on a charge basis and pay at the end of each month. Inasmuch as Bestine sells mostly labor, charge accounts are not generally encouraged.

The average time required to make an installation is, we are told, one hour. This is, of course, very much less than the average all 'round handy man requires due to the availability of proper tools and continual practice. Bestine's men can size up a location, decide on the proper position for poles, wire and download much more rapidly than men who erect antennas only at infrequent intervals.

IROQUOIS men have had many amusing experiences in the course of their work. A dealer sold a battery set out in the country. It was sent out on the store truck three days before Bestine arrived to make the installation. When he did arrive the lady of the house welcomed him with the words: "Thank heaven you are here. Our radio's been playing for three days. We don't know how to turn it off!"

An other case: A dealer instructed Bestine to install an antenna at the home of a Mr. Smith, on Fillmore Avenue. He called, put up the job and left. Two days later he received a complaint from the dealer that the antenna had not yet been erected. He had installed it *next door*, where, curiously, lived another Smith who had, even more curiously, purchased a set on the same day!

Managing

HOW

a "big time" Eastern chain

SELECTS

TRAINS and

DEVELOPS

store salesmen

By *W. W. MacDonald*

FOR six months reports had been coming in to *Radio Retailing* that a certain eastern chain was "going to town." In five short years, we were informed, it had become the acknowledged big-shot merchandiser of its city. Newspaper advertising placed in a local daily gave this sheet more radio lineage than any other in the country. Sales averaged \$80. Salesmen earned \$45 weekly. Thirty-five per cent of its business was "repeat." Competitive retailers were copying sales methods, jobbers were practically bursting a blood vessel to get a toe-hold and even manufacturers were not above ingratiating themselves, with a weather eye on emergency clearance possibilities.

Until late June we avoided calling. For we knew from past experience that while the average independent appreciates the shrewdness of chain management and merchandising methods, few of these are applicable to small business. Then a trip took us through this operator's home town. We stopped off for a quick look-see and we're mighty glad we did. For we ran into one of the most interesting stories of our reportorial career.

Here was a chain owned by a man who got his start primarily by raising merry hob with prices, promptly went "regular" when he had amassed sufficient capital to do so safely. The general manager turned out to be a gentleman with a reputation as one of the fanciest high-pressure artists ever to browbeat salesmen in the bucket shops of distant New York and Chicago. He, too, had gone semi-conservative, not because of any Pollyanna-like change of conscience, but because he discovered it was good business. And the salesmen! Lo and behold, many wore faces that are quite familiar

to habitues of far-off gyp rows. We learned later that most of them were imported, put through a course of sprouts that trained them to sell on a basis profitable to the store, without robbing them of big-city initiative.

The outlet still advertised leaders at a price, we found. But cleverly, in a manner less destructive to the market than similar schemes. Distress stocks are held in the warehouse until other local sources of supply run out. This is advantageous as no one else can "muscle in" on a sale after the advertising breaks. And if there is no stock in other stores no one is directly hurt by the leader, even though it does reduce the size of the market for other products. We found, also, that some direct-from-the-manufacturer buying is still done. But the real backbone of the business is the sale of standard brands and new models at full list. Unknown brands are not, in fact, attractive to the management. The chain finances through a bank. And unknown brands are not good collateral.

Like any other large operator this outlet is not particularly loved by competition. But we are not at the moment concerned with the legitimacy of chain merchandising. For the really important find of our contact was the most intelligent method of selecting, training and developing retail store salesmen that it has recently been our fortune to run across. This chain's rapid rise is unquestionably due more than anything else to the possession of 25 floor salesmen who really know how to sell radio. Know how to sell enough of it to make a good living. And know how to sell it so that the store not only makes money on the initial transaction but gets the customer's repeat business.

Selection, training and development of salesmen is of interest to every retailer, large or small. And so it constitutes our story.

SELECTION

Fully two-thirds of the sales staff are men imported from New York and Chicago high-pressure districts. Classified advertisements in the newspapers of these centers unearth them and correspondence, followed by personal interview, does the rest. There is little turnover in help. Only one man has left in the last two months.

Why pick men who are certain to be too well versed in all the very worst sales tactics? Because, we are told, they are necessarily aggressive. They have to be to live. They know how to apply pressure when it is needed, and they are not afraid to. And such salesmen can be taught to avoid practices which are detrimental to the firm. The most important corrective measure is the payment of a salary sufficient to make gyp selling unnecessary. The average man doesn't like it but, usually because he has worked for shortsighted employers, who saw only the immediate economy of letting men scratch for themselves, is forced to work for himself at the expense of the store. Men are paid in this particular instance, \$20 weekly, plus a 2 per cent

Manpower

commission and extra credits for short-term and cash sales.

Men with the desired experience and initiative are not, it seems, available locally. (One fresh-faced boy from the grocery business was turned down while we were ensconced in the GM's office.) A case in point is the recently "let out" salesman formerly employed by a large and respected department store. He was an experienced radio man but business came so easily in his former job due to tremendous store traffic from other departments that he had grown accustomed to taking orders rather than selling. He simply did not know how to apply pressure when pressure was necessary. If permitted to remain on the staff, earning insufficient money to make an honest living, he would unquestionably have sold on a basis unsatisfactory to the store and to the consumer.

Selection of types socially on about the same level, externally at least, as the average customer is, we understand, of utmost importance. The first thought contributed by the general manager, shortly after he joined the firm, was that ex-stock and bond salesmen would probably make a swell nucleus for a super sales staff. They were tried and flivvered badly. This is curious unless you analyze it. For such men are adept cold-canvassers, sell practically "blue sky" commodities which can neither be seen nor felt. The answer is, simply, that they overawed the average radio prospect. People unconsciously felt that they were being "sold," handled by an expert, rather than waited upon by a clerk.

Elderly, married men are preferred for branch stores, where family trade is prevalent. It is surprising how much more friendly a customer becomes with a store employee when they can chew the rag about each others' kids. Too much drive is a positive disadvantage. Men with more punch, on the other hand, are successfully used in the downtown showroom. There they can push for business without appearing to unduly rush the trade which expects more rapid-fire treatment.

TRAINING

When a new man is taken on, despite the fact that he must have experience in order even to be considered, he is first ushered in to see the Big Boss. There he is told these things with sufficient forcefulness to make them sink in. We heard the story and, hardboiled as we are, it convinced us that the outfit was very much on the level and wanted to keep its salesmen rather than just "use" them.

"1. You are on probation for two months. Consider every customer your Boss. Do for them what you would for me. I'll back you up.

"2. The other men in this establishment earn \$45 weekly. You must do the same to be of any value to yourself or to us. We will help you in every way we can. And it is our job to see that enough customers come into the store to make it possible.

Says the General Manager:

"There is no magic formula for success, unless it is management of manpower. Without it even the retailer with a good location, good merchandise and good prices must certainly fail"

"3. Don't promise the customer anything you cannot deliver. This applies to the performance of sets, delivery dates, free service and terms of payment. Write every promise on the sales slip. We will live up to them, even if it costs us money. BUT, if you promise more than we authorize then we will warn you on the first offense, deduct your commission on the second, third and fourth, and fire you on the fifth.

"4. The aim of this organization is to secure repeat business by fully satisfying every customer, no matter what it costs. New business is essential if we are to grow, but it is on repeat business obtained without great promotion expense that we make our profit.

"8. Live up to our rules, be aggressive enough to make a good living, sell right so that customers do not flood the main office with complaints—and you are a permanent part of this organization. Pressure for volume at our expense, no matter how good your sales are, and you are not."

Following this starting gun the new man is sent out to a district store, where for three days he does nothing but watch older men sell. He soon learns that the Boss was not "giving him a line" about right selling. The conservative policy (for a chain) upon which the organization is building, based almost wholly upon the excellence of its sales staff, sinks in.

Then the new man is transferred to another branch, where he becomes a regular member of the sales staff for the balance of the two-month probation period. He is watched closely by the branch manager, coached in his selling, and when the probation period is over, the manager reports to the main office. The Boss again interviews, decides from the attitude of the man, his

(Please turn to page 41)

Community

*Rasco of Alabama
turns \$2,500 stock
in 8 weeks*

*Plays set at farmhouse
nightly inviting
neighbors in*

Closes next day



The truck picks up a set and batteries, prepares for an evening on the road

FARM product prices are up, radio set prices are down. Less than 25 per cent of the farmers in the Mississippi Basin (P.W.A. report) have radios, and it is probable that nearly half of these are obsolete. Interest charges on personal loans and mortgage indebtedness have declined 20 per cent in the past four years. Rural business is running 19 per cent ahead of urban.

The rural dealer's opportunity to sell sets to farmers, particularly those away from electric light lines, has never been better. The trick is to do it without excessive sales expense. Farms are widely scattered, hard to canvass economically. Yet canvassed they must be for the strong appeal of new farm machinery and other manufactured products offers such severe competition that farmers cannot be expected to buy sets over the counter.

B. C. Rasco, of Cullman, Alabama, has solved his selling problem in a unique way, moving \$2,500 worth of battery radios in 8 weeks. This represents half his business for the period. Here's the story:

ONE DEMO EACH NIGHT







Rasco originally put a \$56.75 set and \$8.50 worth of batteries in his truck every night after closing hours, drove out into the country until he spotted a farm home within sight of several others. He cold-turkeyed the farmer into permitting a demonstration of the set, urged him to invite his neighbors in to hear it at the same time. Working up interest was rarely difficult when the prospect was told that the set used a new battery which lasts

1,000 hours without recharging. And, of course, where it was possible to arrange for a demonstration prior to the call (sometimes possible when farmers come to town on Saturday night and window-shop at the store) the door was open and the household waiting for the show.

On one early demonstration 10 neighbors were invited in and 8 of them eventually sold. It is not often possible to get such attendance, but coverage of 3 or 4 different families at once is not unusual.

If the set is not sold it is put back in the truck, re-

Here's what a
good bat-
tery console
cost the farmer
in 1935

 67 Bushels of corn	 62 Bushels of wheat	 158 Bushels of Oats
 332 Bushels of corn	 174 Bushels of wheat	 506 Bushels of Oats

Here's what a
good bat-
tery console
cost the farmer
in 1933

Demonstration

Moves BATTERY SETS — Keeps SALES EXPENSE DOWN

turned to the store and canvassing activities called off for the evening. Sets are never left for trial. And Rasco finds it best to avoid going from one house to another in any one evening, first because it creates a bad impression, as the initial prospect sees very plainly that he was not particularly favored and, second, because it is generally necessary to drive some distance to the next group of farm homes where arrival is necessarily too late for best results.

Nights are reserved for demonstration. The days following are spent following up and closing. This system works out admirably and is producing volume at low cost. If there is no closing to be done in the daytime Rasco tries to arrange night demonstrations. He has, in fact, now reached a point where it is not necessary to go it "cold" and, naturally, is insured of a larger and more receptive audience.

GETS BATTERY SET SERVICE

Since the Rasco Electric Company obviously specializes in battery set sales and everybody knows about it because of the demonstrations, the company automatically gets considerable battery set service business, which puts them in an ideal position to sell users of obsolete models new equipment. Even other dealers selling locally patronize the store's service department when battery sets come in for repair. On all calls over 7½ miles, a minimum charge of \$2, plus \$1 per hour for time over two hours, is made. Parts are extra. Most sets, however, are brought in by the owners for checkup

and a minimum charge of \$1, plus \$1 per hour, is made for such work. It swells store traffic more than any activity ever tried.

















Farmers are at once interested in new battery sets when told about their trouble-free characteristics and when they have an opportunity to hear a new set using them. Old equipment now in use is so obviously inferior in performance that demonstrations are more convincing than in the case of new all-electric receivers. The reliability of the new sets is further stressed by offering a cover-all guarantee for three months. Only one out of the last 15 sets sold has required any service so the guarantee does not appear to be excessive.

RECOMMENDS FALL PRESSURE

Early fall is best for battery set demonstrations, according to Rasco. "There are few picture shows, bridge parties and dances to distract the attention of the consumer in our market," he advises, "hence preparation for fall and winter entertainment is important. Spring and early summer is not as good as the farmer is busy. In the fall, furthermore, crops are in and sold and the farmer has ready cash.

"Besides advertising in the weekly newspaper we use signs along the highway to advertise our wares. Such signs seem to be very effective here. We also take space on the stage curtains of country schools. This pulls surprisingly well in our rural community and, in addition, we frequently loan the schools sets for special functions. It's a right-good method of advertising.

RISING FARM PRODUCE PRICES MAKE RADIOS EASIER TO BUY

 90 lbs. each 8 LAMBS	 200 lb. each 4 HOGS	 529 lbs. of TOP BEEF STEERS	 213 POUNDS of Butter fat	 199 Dozen Eggs	 508-LBS. of COTTON	 286-LBS. of TOBACCO	 2029-LBS. of PEANUTS
 90 lbs. each 17 LAMBS	 200 lb. each 14 HOGS	 1282 lbs. of TOP BEEF STEERS	 469 Pounds of Butterfat	 442 Dozen Eggs	 1575-LBS. of COTTON	 880-LBS. of TOBACCO	 6901-LBS. of PEANUTS

Courtesy of National Carbon Company

A SERVICEMAN

COLD-CANVASSES

HOW did I become acquainted with my best customers? How did I meet the people who have proved themselves to be such staunch friends? Looking back, I can see it all can be traced to systematic canvassing. Other servicemen should benefit by the relating of my experiences.

Before knocking at a single door, I drew a large map to scale containing all the streets within a mile radius from my shop. I paid several visits to the Registrar of Voters and copied the names of all the residents in that territory. Armed with a list of names, paper, pencil and a supply of cards I set out each morning at nine and knocked on doors until eleven thirty. When the householder came in response to my knock, I would open with: "Good morning. Is this Mrs. Whoosis (or Mr. Whoosis)?" The possible answers to that question are three, either "Nobody by that name lives here," or "I'll call him to the door," or "Yes."

If I received the first answer I would say something like the following: "That must be the reason I haven't heard from Mr. Whoosis lately. My records show he used to live here. I'm the neighborhood radio man and I dropped in to ask him how his radio has been working."

Often I would then receive the exact address that Mr. Whoosis had moved to, and often they would say, "I'm not Mr. Whoosis. My name is Brown, but I have a radio and I wonder what you would charge to test the tubes."

I have made several customers by this method of not forgetting to mention my business when I find that I have the wrong name.

If they offer to call Mr. Whoosis to the door, I thank them and wait and if the answer is "Yes" I continue with, "My name is Kirk. I'm the neighborhood radio man and dropped by to get acquainted and offer to test your tubes free if you wish." If not invited in, I hand over my card and end the visit. I never attempt to use high pressure or insist upon forcing the householder to listen further to me.

I keep a list of all those who are not at home and call back on some morning reserved for back calls only. Failing to find them at home the second time puts their name on another list to be called upon just after dinner at night. Some of these latter names are the best customers because they work in the daytime and depend

upon their radio at night and have the money to pay for radio upkeep.

I worked this canvassing successfully in Los Angeles and built up a list of customers and friends. I have reason to be mighty glad of several acquaintances made by canvassing. When I decided to go into business for myself in Oakland I started the same canvassing, but this time I was fortunate enough to secure a list of telephone subscribers in my "territory." A company here sold such lists. This list is more valuable than a list of voters, because voters lists contain much deadwood, but a telephone subscriber is more or less permanent and responsible. Having the name is the most important thing, in my estimation. The name will get me in where a "cold turkey" canvass would not get me to first base. I have often been invited in to sit down and wait while the person called for was told that there "was someone to see you."

I never leave my card under the door where I find no one home. It is my opinion that advertising matter left on porches is simply 100 per cent wasted, but when you can meet the customer and hand him your card, my experience demonstrates that a surprisingly large number of people will keep that card for years.

IF YOU servicemen reading this will try my canvassing idea, you will have some amusing experiences. You will also have some pleasant experiences and I will admit you will have some unpleasant ones. These latter experiences can be made short by ending the visit at once when you meet a "crab." The increased business and pleasant people encountered will more than compensate for the episodes that rub your fur the wrong way. Besides, you will find most people are happy to meet a radio man. They are all interested in the romance of radio, many are out to take advantage of some free radio advice, and all are

(Please turn to page 54)

By JIM KIRK

who unearths his best customers by ringing doorbells

KIRK ADVISES:

- 1 Stay in your own immediate neighborhood
- 2 Get prospects' names before ringing bells
- 3 Offer to test their tubes free. Never neglect this opportunity
- 4 Call back on people who work all day
- 5 When you encounter a "crab" don't prolong the agony

SIGN NOTHING until you hear this New Miracle of Modern Radio . . . **3RD DIMENSION TONE**

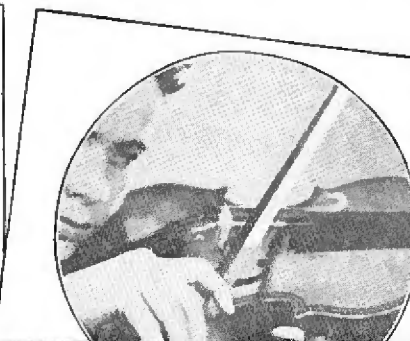
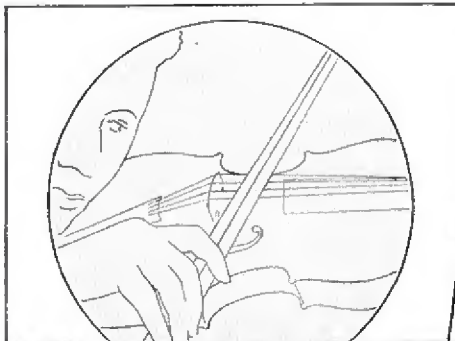

WHAT IS 3RD DIMENSION TONE?

Ordinary Radio

Gives you only the bare outlines of the music in the studio. It lacks the lights and shadows—the contrasts—which make music truly beautiful. It robs you of the subtle overtones which are often the difference between the voice of a talented artist and the ungifted singer.

A Conventional Type Radio of the "Fidelity" Class

Here is an improvement. Certain of the overtones are reproduced—but only of the lower notes. It lacks brilliance—the human voice still retains some of that booming, "down-a-barrel" quality. Such a radio fails to give you the sharply defined high notes with which the musician portrays his musical theme against a background of the "lows."

Fairbanks-Morse 3rd Dimension Tone

Here is something NEW! The latest achievement of radio science! Now you get reality; the living presence of the artists before the microphone; the sharp brilliance of high notes against the mellow softness of the "lows." Radio reception which gives you everything—gives it to you as the composer and artist intended.

NOTE—Fairbanks-Morse 3rd Dimension Tone robs you of nothing—hence, it conceals nothing. It hides neither the defects of the unskilled performer nor the artistry of the genius.

The new Fairbanks-Morse Radio will be the smash hit of 1935. Never before has any radio offered so many outstanding advantages.

It has, in 3rd Dimension Tone, the most spectacular selling feature in radio history.

It offers the most dramatic and convincing demonstration any prospect ever listened to.

It has inimitable eye appeal—superbly styled cabinets embodying construction features never before attempted in any radio cabinet. It is offered in a complete line at prices to fit every home.

It is sold by an organization which, in 105 years, has never failed to fill every obligation to its customers . . . on a basis that assures you a generous profit.

Decide nothing until you have seen and heard this new radio marvel. Wire, phone or write today for full information. Address Fairbanks-Morse Home Appliances, Inc., 430 South Green Street, Chicago, Illinois.

Cable Address: FAIRMORSE—Chicago

FAIRBANKS-MORSE



Radio

GENERAL  ELECTRIC
RADIO
WILL DOMINATE THE

ATLANTA

MARKET

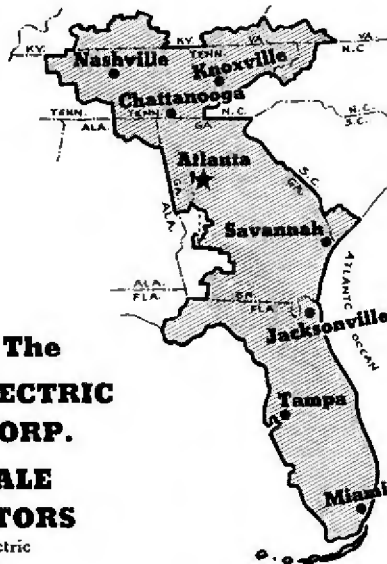

Through The
GENERAL ELECTRIC
SUPPLY CORP.

WHOLESALE
DISTRIBUTORS

of General Electric
 Appliances

- | | |
|---------------------|--------------------|
| Headquarters | Atlanta, Ga. |
| Branches | Chattanooga, Tenn. |
| " | Jacksonville, Fla. |
| " | Knoxville, Tenn. |
| " | Miami, Fla. |
| " | Nashville, Tenn. |
| " | Tampa, Fla. |
| " | Savannah, Ga. |

Says C. R. Pritchard, Mgr., Appliance Sales:—

"There never was a more important date in the Radio history of the Atlanta territory than the date of our dealer meeting at which time we will announce the new General Electric Radio line and merchandising plans. New merchandise — Out of the House of Magic! — new and dramatic advertising — new sales opportunities for dealers — these are but a few of the important subjects to be presented. Watch for the announcement date. It means 'Radio history in the making'!"



YOUR CUSTOMERS WILL PREFER
GENERAL  ELECTRIC
RADIO
 With the tube that's "Sealed in Steel"

SALES



Radio Sam Announcing—

In the evening hours
 If your radio won't click
 Telephone us
 For SERVICE that's quick!

R.A. Belliff 1557 Signing Off!

LOUENSTEIN RADIO SERVICE 5332 N. 16th STREET

Here's a good example of an inexpensive yet effective service-selling postcard. The picture promotes friendly dealing, identifies the serviceman so that he is recognized when he calls. The message pulls business after hours

HOW MUSSON CLEARS OUT TRADES

Keeping used radios and trade-ins in stock is a good way to tie up capital which should be working. The H. E. Musson Company of Oklahoma City, Oklahoma, uses a plan to clear them out that has been effective over a period of years.

Used sets are placed in the store windows with a relatively high starting price. They are left in the window until sold, the price being reduced \$1 per day.

Obviously, people passing the window note the daily reductions. When they become interested they hesitate to await until the set is knocked down to practically giveaway price for fear that some other purchaser will beat them to it. As a result most of the sets go well above the bed-rock cost.

When thieves broke into the Radio Electric Shop of South Pasadena, California, and stole two radios, Ellis Stokes turned his loss into a gain by running a "stop thief!" ad in the local newspaper. It served the double purpose of making the city hot for the thieves and calling to the attention of newspaper readers the fact that the store valued the two sets described sufficiently to want them back very badly.

STOP THIEF!

Reward!

One of the Radios described here, given as a Reward to the Person that gives information leading to the Arrest and Conviction of the party who, New Year's Eve, broke into the

The Two Models Stolen:

R.C.A. Victor Table Model No. 118—5 Tube All Wave. Airplane Dial, dark walnut cabinet. Serial number is stamped on back of Chassis: **052644**

ALSO

"Packard Bell"

6 Tube All Wave Table Model... Airplane Dial... Serial Number stamped on back of Chassis: **121061**

RADIO ELECTRIC SHOP

at 1118 Fair Oaks Ave., S. Pasadena and Stole the TWO MODELS here described.

Information can be given to us by Telephone: **RU 4301 or So. Pasadena Police Dept.**

SHORTS

NOVEL DISPLAY SELLS SHORTWAVES

Shortwave reception of distant foreign stations is becoming more and more important as a sales feature. It is easy to tell people just what stations and countries a particular receiver will tune in, but, as the Chinese say, "One good picture is worth a thousand words."

So here is a description of a window display that will not only help sell shortwave sets, but which will attract attention in the evening, particularly if a receiver is placed in the window with it and illuminated by means of a single, shaded lamp.

Secure a map of the world at least 2x3 ft. in size. Paste it on a piece of heavy cardboard. Make four square strips of wood, $\frac{1}{2} \times \frac{1}{2}$ in. in cross-section and combine these in a rectangular framework with outside dimensions the same size as the map. Fasten the map to the framework, which will support it and hold it rigid.

Now make another framework of exactly the same outside dimensions, but of wooden strips $\frac{1}{2}$ in. thick x 3 in. wide. Nail this to the wall in the place the map is to be located. Cover the back of the framework with three-ply veneer.

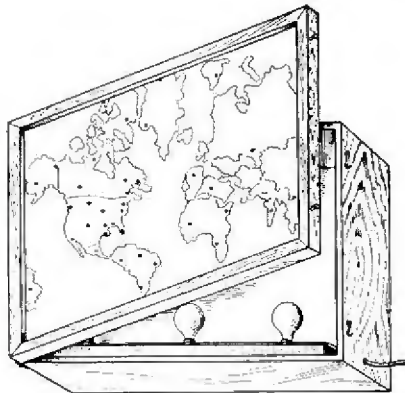

Hinge the map framework at one edge to the framework mounted on the wall. A hook fastener should be provided to hold the frames together. This leaves a closed space $3\frac{1}{2}$ in. deep behind the map. Paint the inside of the "box" with white lead paint. Mount two or more electric light sockets to the inside of the framework back of the map and connect the supply wire to the light lines through a snap switch. The number of sockets used will depend upon the size of the map. Frosted lamps are placed in the sockets. The two frameworks should fit tightly to avoid leakage of light around the edge of the map.

Punch holes in the map with a heavy scarf pin to indicate cities heard. Paste a piece of white tissue over the hole, on the back of the map. Use red tissue for foreign countries, green for code stations at distant points, if the receiver tunes them in. Put a key list to the colors down in the lower left corner.

When the map is lighted up it will not only aid shortwave set sales but will constitute an excellent evening window display.

More Sales Shorts on Next Page

GENERAL ELECTRIC
RADIO
WILL DOMINATE THE

BALTIMORE

MARKET



Through The
GENERAL ELECTRIC SUPPLY CORP.
WHOLESALE DISTRIBUTORS
of General Electric Appliances

Headquarters . . . **Baltimore, Md.**
Branches . . . **Charlotte, N. C.**
" . . . **Greensboro, N. C.**
" . . . **Norfolk, Va.**
" . . . **Richmond, Va.**

Says B. J. Dischinger, District Manager:—

"Mr. H. C. Maccubbin, District Manager Appliance Sales, our Salesmen, and myself, are all pledged to bring to you quickly and accurately the Sales Story on the new wonderful General Electric Radio which is a development of the 'House of Magic'.

"The new General Electric Radio Line is distinctly a General Electric Product, manufactured in their Bridgeport Plant and supported by an Advertising and Promotional Campaign that will be excelled by no other in the industry. Our sales plan carries with it a restricted franchise dealer policy."

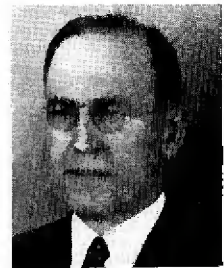

YOUR CUSTOMERS WILL PREFER
GENERAL ELECTRIC
RADIO

With the tube that's "Sealed in Steel"

GENERAL  ELECTRIC

**RADIO
WILL DOMINATE THE**

**BIRMINGHAM
MARKET**

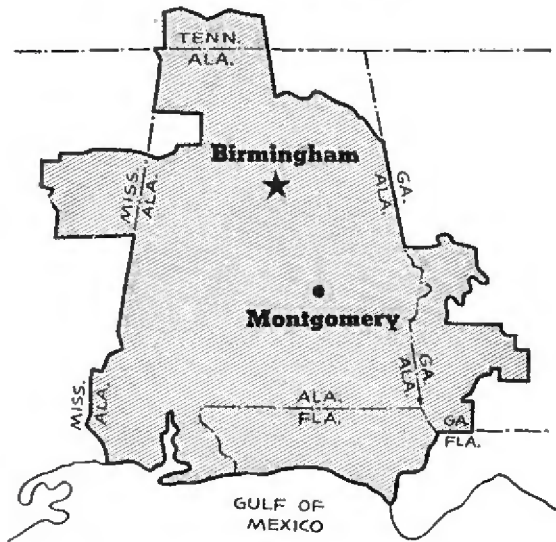

**Through The
MATTHEWS ELECTRIC SUPPLY CO.
WHOLESALE DISTRIBUTORS**

**Headquarters . . . Birmingham, Ala.
Branch Montgomery, Ala.**

Says C. R. Matthews, Vice-President:—

"In our twenty years of distribution of merchandise products for the General Electric Company, I think nothing has given us more enthusiasm than the announcement by them of their new radio receiving sets, made possible by the 'House of Magic'.

"The new dealer merchandising policies and the aggressive program of promoting General Electric Radio should appeal very strongly to the dealer, and we are confidently looking forward to the most successful season in the history of our Company."



**YOUR CUSTOMERS WILL PREFER
GENERAL  ELECTRIC
RADIO**

With the tube that's "Sealed in Steel"

More **SALES**

CANCELS SERVICE CHARGE IF—

"Three of these tubes definitely should be replaced. The others are weak and will give trouble in the near future. Our regular service charge, per home call, is \$1. If you will buy a complete set of new, *matched* tubes now we will cancel the service charge for this call." G. Fox & Company, Hartford, Conn.

TIN-LIZZIE" TEST



Bill Toth of Cleveland uses a sales stunt that he claims is swell for convincing auto-radio prospects that his sets can "take it." He picked up an old Model "T" Ford, installed a modern radio complete with the necessary suppression in it, equipped the car (if it may still be classified as such) with the sign shown in the photo and a dummy horn to attract attention.

"When our Lizzie jolts down the street like a bucking broncho and its radio continues to sound like a million dollars the combination is so incongruous that people stop and stare. We park it at a busy intersection, demonstrate, hand out circulars and make appointments for home demos.

"Our motto is: 'If It works in a Model T, it will work in anything!'"

**FILL THE
SHELVES**

"For a short-time special inducement try the following," states a dealer in Maine. "Fill a refrigerator with a properly selected full complement of food, including liquid refreshments. Advertise that, for a week only, every refrigerator sold will be delivered filled as per sample and without extra cost. Put in a window trim. Photograph the food-filled shelves and run an illustrated ad in the newspaper."

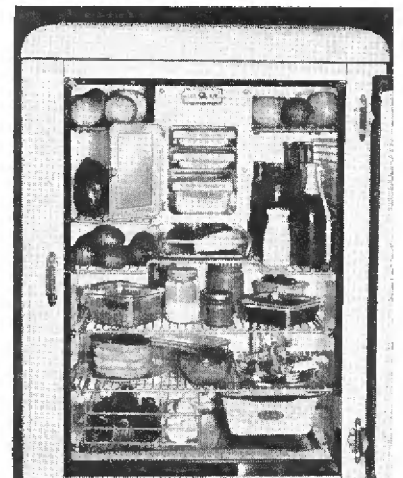

Courtesy Leonard Refrigerator Co.

SHORTS

"PORCH-SIDE" AUTO-RADIO SELLING

J. Miller of Red Bank, N. J., has hit on a swell method of selling auto-radios house-to-house during the summer months without "getting in the prospect's hair." "Have your salesmen drive out into the residential district in a radio-equipped car several evenings a week. Instruct them to simply pick a house where several people are taking it easy on the porch, park at the curb and let 'er play awhile. The chances are ten to one that someone will drift down to the car to hear the set (auto-radio is still a novelty to many) and if they do, the ice is broken for a sales talk.

"If no one stirs from the porch it is a cinch for the salesman to leave the set playing in his car and go up to them for a solicitation. The fact that set is in operation takes most of the sting out of the canvass. We have been highly successful in outside selling of car sets using this modified canvassing method."

TWO-PRICE SALE CLEANS UP "SECONDS"

G. Jesse, manager of the radio department for the Davidson Furniture Company of Kansas City, Missouri, ran a "two-price" sale on used sets, moved 95, most of them for cash even though the concern is a credit house.

He simply cleaned up all the trade-ins in the store, had the service department check them over and put them in the best shape possible, then divided them into two groups, one to sell for \$20 flat, the other for \$10. They were advertised over the air, during the concern's daily "spot" announcement broadcasts, in the newspapers and in the windows. The prices quoted were for cash only, a substantial addition being made for credit transactions.

"It cleaned out our entire stock of used receivers," states Mr. Jesse, "completely freeing us for the sale of new merchandise. All of the sets sold were good machines, with plenty of extra service left in them. They weren't new sets, by any means, but they were well worth the money. We took no trade-ins, of course, so the stunt made a clean sweep."



"STARS OF THE FUTURE"

With the cooperation of Edwards and Walker Co., Fairbanks-Morse distributor at Portland, Maine, the Keith Theatre recently awarded a radio to the winners of an audition contest to pick future radio stars. This attractive display of Fairbanks-Morse radios in the theatre lobby stimulated interest in the contest.

GENERAL ELECTRIC
RADIO
WILL DOMINATE THE

BOSTON MARKET

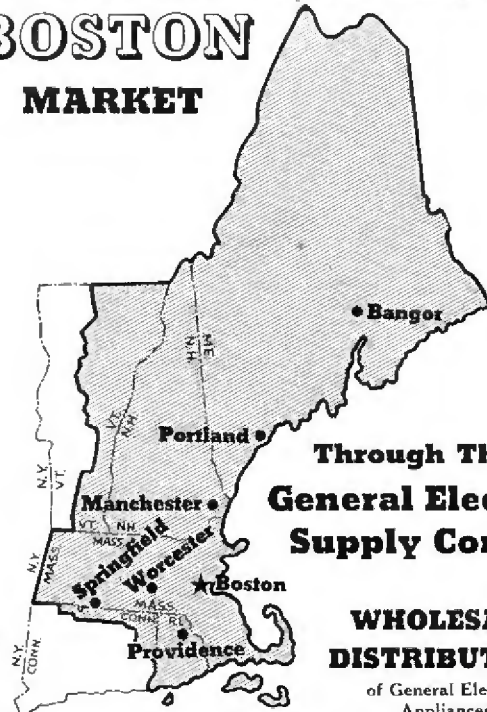

Through The
General Electric
Supply Corp.

WHOLESALE
DISTRIBUTORS
of General Electric
Appliances

Headquarters	Boston, Mass.
Branches	Bangor, Me.
"	Portland, Me.
"	Providence, R. I.
"	Springfield, Mass.
"	Worcester, Mass.
"	Manchester, N. H.

Says *W. H. Kaiser, District Manager*:—

"There has never been a greater opportunity for radio dealers to establish themselves profitably than now. Realizing this, dealers all over New England are indicating this desire so that they may definitely capitalize on the latest and greatest development of the 'House of Magic'.



"The General Electric Supply Corporation welcomes the opportunity of serving its dealers so that together we may profit from the greatest radio promotion that any manufacturer has ever had."

YOUR CUSTOMERS WILL PREFER
GENERAL ELECTRIC
RADIO

With the tube that's "Sealed in Steel"

**GENERAL  ELECTRIC
RADIO
WILL DOMINATE THE**

**BUFFALO
MARKET**



**Through The
GENERAL ELECTRIC SUPPLY CORP.
WHOLESALE DISTRIBUTORS**
of General Electric Appliances

Headquarters Buffalo, N. Y.
Branches Erie, Pa.
" Rochester, N. Y.
" Niagara Falls, N. Y.

Says D. B. White, Manager, Appliance Sales:—

"Now that the engineering, manufacturing and merchandising of General Electric Radio are all under one roof at Bridgeport, Connecticut, we confidently look forward to an outstanding line of receivers supported by a vigorous advertising and promotion campaign. To this we will add our own aggressive support in helping General Electric radio dealers in this territory realize their full sales potential on a profitable basis."



**YOUR CUSTOMERS WILL PREFER
GENERAL  ELECTRIC
RADIO**
With the tube that's "Sealed in Steel"



ALBANY—To *Whitney's* goes the palm for the largest local advertising appropriation of the early summer season. This retailer cleared out 1935 floor samples at from \$33.95 to \$94.90 (You can tell from the pennies that this is department store copy!), played up a flat \$10 trade-in allowance on a \$49.95 Philco, advertised a Westinghouse 6-tuber (regular price \$69.50) at \$41.75 as a special sale, tied up with the Baer-Braddock fight featuring an RCA console, listing at \$89.95, for \$69.95. Shot the works with a quarter-page bid for store-traffic with the "Air Queen" compact at \$8.95.

The *Philco* jobber engineered a full page co-op with a quarter-page editorial squib by general manager Houghtaling (*Roshin*), a stock quarter-page mat furnished by the factory. *Swire*, *Braun*, *Breslaw*, *Whitney* and *Fern* tied in.

Braun splashed with a half-page commemorating the firm's 16th anniversary, devoting a corner of it to *Philco*, featuring \$1 down, liberal allowances, lower than list prices and used sets at \$5 up. Repeated the bid for radio business in a later quarter page on refrigerators with a set-promoting insert.

Western Auto was right up there, banging the market in the eye with "Truetone" auto-radios at \$29.95, then \$19.95 at \$2.50 down and \$1.25 weekly. Ten-day trial also offered for \$3 down, on a money back guarantee.

Ward popped a \$34.95 console bearing the same name, \$4 down, \$5 monthly, with a small carrying charge. *Swire* Radio dumped a quantity of *Majestic* Internationals originally sold for \$17.95 at \$9.95, unloaded used sets at \$5 up.

BALTIMORE—*Zamoiski* (distributor) took a quarter in several papers, using a standard *Philco* mat on new 1936 sets. The *Gas & Electric Company* craftily tied in with a vertical single-column "ben-day" cut plugging the same stuff. Looked like a *Power Company* splurge.

May concentrated on cutting the prices of table models, causing considerable furor in town. Featured 25 *Grunow's*, labelled "regularly \$22.50," at \$12.95. Obviously a leader. A *Ferguson* extended-band compact pulled at \$8.88, gave *May* a crack at sell-up trade.

Pollack's took a half, split it between washers and the *Philco* 118X at 100 bucks less a flat 25 for trade-ins. "Use your credit, just charge it" identifies the store as a strong bidder for time payment business. *Stanley* concentrated on the *RCA* line of auto-radios, offering them without benefit of down-payment with free installation and aerial. \$1 per week.

Taubman's pulled 19 cent tubes of unidentified brand out of the hat in time for the *Baer-Braddock* shindig, one of the few examples of tube advertising seen this month. Small line beneath price said 201-A's only . . . which makes everything clear. We found this slug with our trusty pocket microscope. A similarly uni-

ARE PLUGGING

Review of Newspaper Ads

There is no better index of merchandising activity than newspaper advertising. In reviewing it one learns much about the state of the market. And occasionally picks up an effective copy idea.

identified auto radio was placed on the block at \$18.95, less installation.

Western Auto popped up again with "Truetone" auto-radios at \$21.95, changed its mind and made it \$20.95 in the next ad. The branch in Albany still has the edge by one smacker!

Blum's tucked a Philco auto-radio away in an obscure corner of a furniture ad. But small radio space is better than none at all. And it is interesting to see a furniture outfit putting some steam behind car sets.

BUFFALO—*Adam, McIdrum & Anderson*, despite the hot-weather lull in radio interest, ran several ads concentrating just on radio service, threw in public address rentals. Used type in small ads effective. Stand off five feet and you can still read the essentials: "Radio Service . . . Phone Washington 4050." These lines printed white on black background. *A.M. & A.'s* used the same reverse cut stunt to plug Philcos on easy terms.

Buffalo General Electric (Utility) printed a classy looking photo of a Mrs. Taffel, told how cheaply she runs her radio because of the low cost of juice. Radio dealers got a free ride on this splurge. Thanks, Buffalo. *Howard's* was far and away the big spender of the month, this credit house playing up a variety of unnamed compacts, plus the "Monarch" at \$9.85 and the little GE all-metal 4, a set we thought was off the market, at \$12.95. This little job certainly has worked overtime around the country as a leader.

Levy's kept the pot boiling almost as hot as Howard, featuring the "Worldwide" (can't say if this is a name or just a class of shortwave job) midget at \$24.50, 50 cents down, 75 cents weekly. Also splashed the "General" (not G.E.) auto-radio 7 at \$24.34, 34 cents down and as many weeks to pay. A genuine General Electric car set went under the hammer at \$29.95 (originally \$52.95) in celebration of the outfit's 34th Birthday. A "bedroom" radio . . . not a bad selling title this . . . tied in at \$9.34.

Battery and Starter pushed Motorola at full list "for the fourth," *J. N. Adam* offered American Bosch holdovers regularly \$44.95 and \$19.95 at \$26.95 and \$10.95. *Gamler's* presented an a.c.-d.c. compact on time for \$7.95. *Goodrich Silvertown* mixed Motorolas at \$37.50 in with tire ads. *Household Outfitting* gave away a Philco midget for just \$1 above the cost of a purchased living room or dining room suite, using the set as a premium. The omnipresent *Western Auto* and its \$19.95 "Truetone" popped up again. *Schwegler* offered \$50, no questions asked, for trade-ins, against new Zenith purchases. *Dynac* reduced the RCA M105 from \$39.95 to \$19.95. *Denton, Cotlier & Daniels* "cleared away" \$59.95 RCA's (Gets Europe) at \$35.97. *Melzer's* had the same buy so it must have been an offer passed on generally to dealers by some distributor. And *E. E. Edwards* stuck to nice,

(Please turn to page 54)

GENERAL  ELECTRIC
RADIO
WILL DOMINATE THE

CHICAGO

MARKET



Through The
GENERAL ELECTRIC
SUPPLY CORP.

WHOLESALE
DISTRIBUTORS
of General Electric
Appliances

- | | | |
|---------------------|-----------|--------------------------|
| Headquarters | | Chicago, Ill. |
| Branches | | Indianapolis Ind. |
| " | | Milwaukee, Wis. |
| " | | Rockford, Ill. |
| " | | Appleton, Wis. |

Says *A. J. Millington, Jr., District Manager*:—

"The General Electric Radio Franchise will be a valuable asset to any dealer's business in 1935. First in the field with metal tubes and other advanced developments, the General Electric Radio line will be known in the radio industry as the 'hot' line of the season. The General Electric Supply Corporation has increased its facilities to serve you. Phone for our sales representatives to call, or visit our showroom for complete details concerning the Profit Line of General Electric Radio."



YOUR CUSTOMERS WILL PREFER
GENERAL  ELECTRIC
RADIO

With the tube that's "Sealed in Steel"

**GENERAL  ELECTRIC
RADIO
WILL DOMINATE THE**

**CINCINNATI
MARKET**

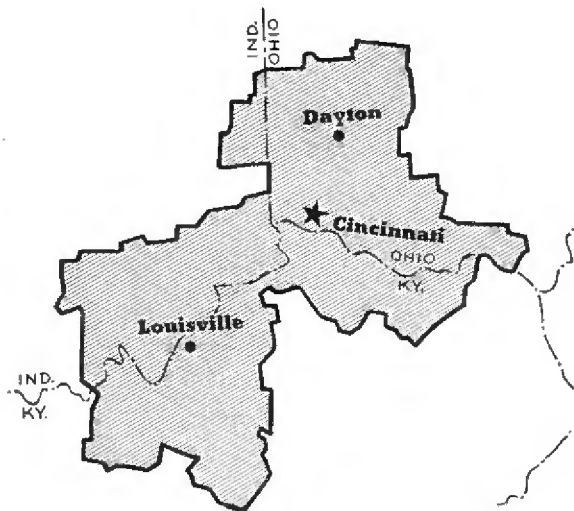

**Through The
GENERAL ELECTRIC SUPPLY CORP.
WHOLESALE DISTRIBUTORS**
of General Electric Appliances

**Headquarters . . . Cincinnati, O.
Branches . . . Dayton, O.
" . . . Louisville, Ky.**

Says R. R. Hand, Manager, Appliance Sales:—

"We believe the time has come to make a *business* out of the radio business and that the forthcoming General Electric Radio program will do just that. Our entire personnel is eager to help you get this program under way. Watch for the announcement of our dealer meeting."



**YOUR CUSTOMERS WILL PREFER
GENERAL  ELECTRIC
RADIO**
With the tube that's "Sealed in Steel"

*Shortwave
"DX'ing" Aid*

When foreign shortwave stations announce their call letters these are sometimes difficult to identify because the letter-sounds used in other countries may be widely different from ours. The following tabulation, which gives the phonetic English sound of numerals and the 26 letters of the alphabet as pronounced in French, Spanish, German and Portuguese, will be useful to dx-hunters.

Pass the information along to your customers.

	FRENCH	SPANISH	GERMAN	PORTUGUESE
A	ah	ah	ah	ah
B	bay	bay	bay	bay
C	say	say-thay	say	say
D	day	day	day	day
E	ay	ay	ay	ay
F	ef	effay	ef	effay
G	zhay	hay	gay	hay
H	asch	ah-hay	hah	ah-hay
I	ee	ee	ee	ee
J	zheep	ho-tah	zhay	ho-tah
K	kah	kah	kah	kah
L	el	ellay	el	ellay
M	em	emmay	em	emmay
N	en	ennay	en	ennay
O	o	o	o	o
P	pay	pay	pay	pay
Q	coo	coo	coo	coo
R	air	erray	err	erray
S	ess	essay	ess	essay
T	tay	tay	tay	tay
U	eu	oo	oo	oo
V	vay	vay	fow	vay
W	doublevay	dooblway		dooblway
X	eeks	ekis	ecks	ekis
Y	egrek	egreyeyah	egrek	egreyeyah
Z	zed	zed	tset	zed
1	unh	uno	ine	um
2	dur	doce	zwi	dois
3	trwa	trace	dri	tres
4	kath	kuahtro	feur	quattro
5	sank	sinko	finf	sinko
6	seece	sase	sex	sase
7	saat	sate	seeben	sate
8	hweet	ocho	oct	oito
9	nerf	nu-avy	noin	nove
10	deece	de-uz	zane	deuz
11	onze	onse	elf	onze
12	doze	do-ee	twelf	doze
13	traze	trece	trizane	tres
14	katorz	catorce	feurzane	katorz
15	kanz	quince	finfzane	quinze
16	saze	dieciseis	sexzane	dezeseis
17	deece-satt	dieciseite	seebenzane	dezeseite
18	deece-hweet	dieciocho	octzane	dezoito
19	deece-neuf	diecinuahvy	noinzane	dezanove
20	vant	vane-tah	tswansig	vinte
30	trahnt	tranetah	drysig	trinta
40	karant	quarantah	feurzsig	quarantah
50	sankant	sinquenta	finfsig	sincuenta

Try These for TUBE SALES

Here are six methods retailers have used to increase tube sales. They are adaptable to the average radio business and require very little expenditure. All have proven successful.



1. Hire, on a small salary or on a commission basis, young high school men who are studying radio, to call on home owners in their spare hours. Equip these men with tube checkers and a kit of the most frequently used tubes. Tube sales, service and new merchandise leads and much useful information are thus obtained at a very low fee.

2. Write or telephone set owners every 10 months following date of purchase of the radio receiver. Keep tube replacement business "at home."

3. Send out thirty second announcements over local station—"How does this program come in? "How does this program come in? If indistinct, phone the Blank Radio Company for a free tube check up."



4. A window trim of very old sets massed on left-hand side. On the right, the very latest receiver. In the foreground, a neat display of new tubes. A sign above the old set reads: "Does your radio sound like these?" Another above the new set asks, "Or does it sound like this set?" A large arrow points to the tube display above which a card stating, "Here is the reason—your tubes. Have the bad ones replaced right now. Come in—we'll be glad to advise you."



5. Have the store staff call people at random while not busy at their routine work. Select names from telephone book. The customer is first asked if he owns a radio set. If the reply is affirmative, the quality of the previous evening's reception is questioned. Whenever the slightest complaint is made the suggestion that the store's tube-checker be sent over for a free inspection is made. Use this method during mornings and the early forenoon.

6. Radio logs are fine tube sales builders. List the local and easily heard programs. Print and mail a new schedule every 90 days. It's the follow up that counts.

GENERAL  ELECTRIC
RADIO
WILL DOMINATE THE

CLEVELAND MARKET

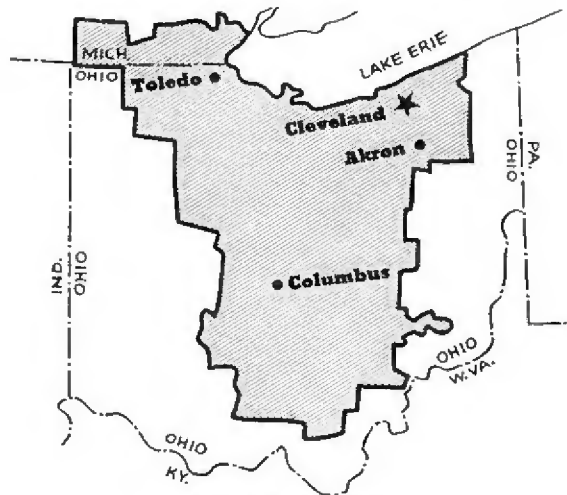

Through The
GENERAL ELECTRIC SUPPLY CORP.
WHOLESALE DISTRIBUTORS

of General Electric Appliances

Headquarters	Cleveland, O.
Branches	Akron, O.
"	Columbus, O.
"	Toledo, O.

Says R. J. Lewis, Manager, Appliance Sales:—

"With the General Electric Radio program starting from scratch in every phase—engineering, manufacturing, merchandising — and all concentrated in one place, the results, expressed in added opportunities for dealers, can hardly be estimated. We stand ready to serve those dealers who recognize a magnificent sales opportunity when they see it."



YOUR CUSTOMERS WILL PREFER
GENERAL  ELECTRIC
RADIO

With the tube that's "Sealed in Steel"

NEWS OF THE MONTH

MANY SPECIAL FEATURES OF ZENITH LINE ACCLAIMED AT DISTRIBUTOR CONVENTION

Will Use "Metaglass" Tubes—Make Aggressive Bid for Battery Receiver Business

CHICAGO—In a three-day convention of over 100 distributors, an affair bristling with innovations, the Zenith Radio Corporation signalized its energetic entry into the 1935-36 radio season. "We're giving the trade and the public feature after feature they can see, that can be demonstrated as new and better," was the key thought as stated to the writer by E. F. McDonald, Jr., president of this Chicago concern. These talking points, presented Thursday morning, June 20, by the irrepressible C. T. McKelvy, revolved around such items as "Triple Filtering," single and dual speakers mounted on a series of three laminated sounding boards, very large, open-faced dials—black body with the markings showing vividly in three colors according to the wave band in use—oversized chassis and, last but not least, "Metaglass" tubes. The latter use the new metal base design but a glass envelope—thus assuring prompt delivery of the new line this summer and provision for the all-metal tube when available in quantities and providing the public wants them. The metal product will be interchangeable with "metaglass."

The line consists of 15 line-powered models and four battery-operated receivers. Priced from \$20 (4-tube table) to \$159.95 for a 12-tube console. Also included were three "Stratosphere" models at from \$375 to \$750.

But the real sensation was sprung by sales manager E. A. Tracey in announcing Zenith's determination to go after the rural prospect as never before. To this end Zenith is bringing out a complete line of battery operated sets attractively priced. Furthermore, this outfit has not overlooked the rapidly growing popularity of 6 volt generators driven by wind power as a means of keeping the storage battery continually charged. Purchasers of Zenith battery sets may obtain one of these devices on attractive terms. (Loud applause from Al Schneiderhahn and all other jobbers from the sticks.)

Zenith advertising plans for '36 are elaborate and include an intensive schedule of broadcast spot announcements. The display material, as presented by advertising

manager Parker Ericksen, seemed to more than fill the bill.

The "Floor Plan," the financing of summer stocks for dealers, is another of this season's innovations. Zenith dealers may avail themselves of this accommodation, also of a time payment contract purchase service.

Always a feature of Zenith affairs, the cruise across Lake Michigan, on Wednesday, was a delightful climax to an enthusiastic gathering. For this purpose Commander McDonald, as usual, provided his private yacht the *Mizpah*.

Under the Palms



Our candid camera catches Bob Mailhouse, president Plymouth Electric Company, New Haven, Conn., chatting with Ross Howard (right) manager, Zenith Radio Distributing Corp., Chicago.

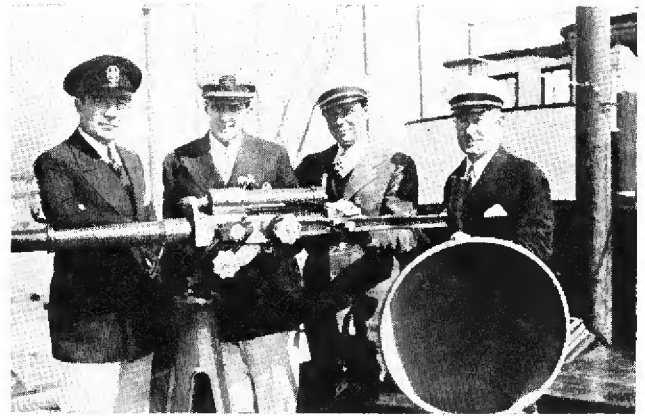

"We'll Fight It Out on This Line!"

The "works" behind Zenith Radio Corp., Chicago. The "one pounder" is superfluous this season in view of Zenith's 1936 models, according to E. F. McDonald, Jr. (left), president of Zenith and Master of the *Mizpah*. Next to Commander McDonald, left to right, E. A. Tracey, vice president in charge of sales; Irving Allen, responsible for Zenith's national advertising and Hugh Robertson, executive vice president.

RMA VOTES TO INCREASE SALES PROMOTION BUDGET

Muter and Other Officers and Chairmen Re-elected—Banquet a "Sell Out"

CHICAGO—The extension of plans to popularize short-wave tuning—through the wider publication of foreign programs in newspapers—many committee meetings and a sell out banquet characterized the 11th Annual Convention of the Radio Manufacturers Association at the Stevens Hotel, Chicago, June 11-13.

Leslie F. Muter, of Chicago, was elected to succeed himself as president for the ensuing year. Without exception the other officers were also re-appointed. The personnel of many committees also remains practically the same as 1935.

The convention was primarily for the discussion of manufacturing problems in committee sessions or by the Board of Directors. The one general meeting was devoted to a reading of reports on the activities of the various committees during the past year.

Price Filings Voted

Voluntary continuance of a few beneficial features of code operations were arranged for, but without any formal action or resolutions except for development of a plan to continue filing by set manufacturers of open prices. Existing wage scales will be generally continued voluntarily, according to those present.

In the discussions of industry problems resulting from annulment of NRA, a feature of the convention was a stirring address by John W. Van Allen of Buffalo, the RMA general counsel, criticizing the "New Deal laws." He declared many were contrary to the American plan of government and individual freedom. He deplored "usurpation of political power," declared that the American plan was for a "government of laws, not of men," and that the latter would lead to political despotism.

There were no merchandise displays and little trade attendance at the manufac-

turers' Chicago meeting.

Further development and increased funds for national sales promotion were voted by the RMA directors. Chairman Powel Crosley of the Sales Promotion Committee reported substantial success and need for enlargement of the RMA promotion projects.

RWA Carries On

CHICAGO—At a meeting of the directors of the Radio Wholesalers Association held at Chicago, June 21, it was de-

ecided to maintain the office and executive facilities of this organization despite the fact that the Supreme Court ruling has made the Radio Wholesalers Code an inoperative instrument.

Executive vice-president H. G. Erstrom is now at work on plans for a combined public and trade show of all radio-electrical appliance interests, scheduled for an early fall dating.

Jobbers interested in association activities can reach Mr. Erstrom at 185 North Wabash Avenue, Chicago, Illinois.

GENERAL ELECTRIC ALL METAL SETS MAKE INITIAL BOW AT CONNECTICUT CONVENTION

Eight Models, "The Result of Two Years' of GE Engineering Development," Enthusiastically Received—Local Meetings Now Being Conducted

BRIDGEPORT—Long awaited by the trade, the new line of radio receivers designed and manufactured by the General Electric Company was introduced to distributors, Friday, June 21. All New England and New York state jobbers as well as 26 export representatives were in attendance. The following week a similar meeting was held in Chicago. Other key distribution points were given an opportunity to view the first eight models in the GE line. As expected every model had a full complement of metal tubes.

Ben C. Bowe, manager of radio sales, prefaced his remarks with a review of the development of radio and the vital part the GE organization has played in its history. Stated that

he expects this year's total set sales to exceed *Radio Retailing's* figure of 4,000,000 sets sold last year.

each refrigeration prospect turned in by a club member and sold, said young man or woman gets a mileage stamp good for one mile credit for every dollar involved in the sale. \$800 represents the entire 800-mile journey, personally conducted, and a "graduate trained nurse will accompany the party."

Engineer J. J. Kaar dwelt at length upon the two years of painstaking engineering development conducted by GE technicians. Using lantern slides, Mr. Kaar gave realistic evidence of the care which will be used in testing speakers and chasses and in assembling each model on its own straight line production belt. For the first time GE gave the details of the many reasons why, in its opinion, metal tubes are definitely superior to the older glass product. Following Mr. Kaar's address the line was presented by sales manager Bowe.

Arcturus Out With Metal-Based Glass Tubes

NEWARK — The Arcturus Radio Tube Company, this city, has just announced a line of 10 glass tubes mounted on bases identical to those used with metal tubes. Characteristics are said to be identical also.

Type designations of the new tubes also correspond with those used by metal-line makers but the letter G succeeds these to differentiate.

GE is instituting a Direct Service Plan. This will be operated through the dealer and is designed to insure the immediate servicing of all GE sets. In line with this policy an ample supply of metal tubes will be shipped to each

8 Men—Will They Lift Television Out of the Lab?



RCA has appointed this inter-company group of radio and electronics experts to plan television field tests, scheduled to start in from 12 to 15 months when experimental transmitters and receivers are ready. Left to right: C. W. Horn (NBC); J. C. Warner (Radiotron); E. W. Engstrom (RCA Television Division); C. H. Taylor (RCA Communications); R. R. Beal (RCA Research); O. B. Hanson (NBC); W. R. G. Baker (RCA-Victor) and H. K. Norton (RCA).

Grunow Jobber Launches "Trip to Washington"

HARTFORD — Long noted for his unique sales building ideas, Francis Stern, Hartford, Conn., crashes through again. This time it's a long pull proposition, scheduled to break April 14-17, 1936.

Advertised as an educa-

tional and patriotic pilgrimage to Washington, D. C., the appeal is to High School students of Connecticut, Vermont and Massachusetts. Each candidate first enrolls with a Grunow dealer in the Carrene-Washington Club. For

"GE MEN" These Executives Will Provide the Push Power



J. L. BUSEY, manager of Appliance Sales, rates 25 years in the electrical industry, as a retailer and distributor.



R. J. CORDINER, is chairman of the Management Committee, governing board of General Electric for its radio division.



B. C. BOWE, manager of Radio Sales for the past five years has complete charge of all radio sales activities.



HAYES CLARKE, assistant to Mr. Bowe is supervisor of G-E radio field promotion and dealer development.



J. W. McIVER, manager of Appliance Sales Promotion, is known through his work on Mazda lamps and Radiotrons.



C. T. WANDRES, in charge of advertising, has been engaged in radiopromotional work since the beginning of broadcasting.

**GENERAL  ELECTRIC
RADIO
WILL DOMINATE THE**

**DALLAS
MARKET**



**Through The
GENERAL ELECTRIC SUPPLY CORP.
WHOLESALE DISTRIBUTORS**
of General Electric Appliances

- | | | |
|---------------------|-------|--------------------------|
| Headquarters | • • • | Dallas, Tex. |
| Branches | • • • | Abilene, Tex. |
| " | • • • | Amarillo, Tex. |
| " | • • • | Houston, Tex. |
| " | • • • | New Orleans, La. |
| " | • • • | San Antonio, Tex. |
| " | • • • | Shreveport, La. |
| " | • • • | Fort Worth, Tex. |

Says H. R. Worthington, District Manager:—

"We sincerely believe that the opportunity of a business life time lies before a certain group of aggressive Radio Dealers who recognize the aims and plans of the General Electric Radio Department.

"This new and revolutionary line of General Electric Radio is a development of the 'House of Magic', and certainly represents the greatest advancement in radio receivers since the introduction of A.C. Radio.

"It will pay you to investigate."



**YOUR CUSTOMERS WILL PREFER
GENERAL  ELECTRIC
RADIO
With the tube that's "Sealed in Steel"**

Grace Before Eats

George Eltz (left) offers thanks for what he is about to receive, free. G.E. heads radio sales for GE out of Hartford



jobber with the initial delivery of the merchandise. As of June 1, list prices on metal tubes had not been fully determined. These will be announced later.

J. W. McIver, dynamic manager of sales promotion, had little difficulty in raising enthusiasm to new heights when he outlined the very ambitious advertising program to be launched. This will

GE Contracts Corporation. It was explained by J. L. Busey that GE's resale policies, as well as the design of the sets, were based upon extensive field surveys and many consultations with retailers whose responsibility it will be to move this merchandise.

The convention concluded with a banquet in the ballroom of the Stratfield Hotel, Bridgeport. Mr. Cordiner took advantage of this opportunity to display original "way bills" showing that the new sets were already in actual transit to various distributing points.



He Reads the "Trib"

Stanley Goodman (right), Royal Eastern Electrical Supply Co., New York, and salesman, can't stand the sun—at GE party

"GE" Men View Sets at Waldorf

Departing from the customary convention idea, eastern dealers were afforded a four-day opportunity to view, at their leisure, the new General Electric receivers which were shown at the Waldorf-Astoria, New York City, July 7 to 10. This affair gave W. D. May his first opportunity to take an official bow as sales manager for the recently established Radio Division of GE's Metropolitan district. Mr. May will contact dealers in New York state, New Jersey and Connecticut. "Winnie" formerly represented Philco in this area and, more recently,

consist of an advertising schedule in *Saturday Evening Post*, *Collier's*, *Time*, newspapers and trade publications. Approximately \$1,000,000 will be spent in cooperative advertising alone.

The display of dealer help material which followed was one of the most elaborate ever viewed at any convention. One of the biggest hits was the GE "Band Master" doll.

Will Franchise Dealers

A Certificate of Appointment will be granted dealers who measure up to the GE requirements, according to Ralph J. Cordiner, chairman of the management committee. Jobbers likewise will receive exclusive territories.

Time payment financing will be available through the



D. W. MAY—who has joined the GE Company, New York office, in charge of set sales

was head of several of his own activities.

Earle Poorman heads appliance sales for GE at its New York office, ably assisted by

John Wood, sales promotion manager (formerly with RCA in a similar capacity).

Following the New York showing, these executives journeyed to New Jersey where open house was maintained at the Hotel Douglas, Newark, from July 11 to 13, inclusive.

Olesen Assists Weston G.S.M.

NEWARK—Harold L. Olesen is now assistant general sales manager, the Weston executive personnel now stacking up as follows: H. L. Gerstenberger, sales manager; H. L. Olesen, assistant general sales manager (formerly in charge of instrument sales); V. E. Jenkins, in charge of radio and broadcasting instrument and equipment sales; R. T. Pierce, in charge of photocell equipment sales; Putnam, in charge of industrial business and H. M. Ricks on aviation and educational work. Syd Cassey heads the advertising department.



\$6,000 a Mile

Here are two views of a short length of coaxial cable now being installed between New York and Philadelphia (90 miles) by the A. T. & T. at an estimated cost of \$6,000 per mile. Designed to carry 200 regular telephone conversations in each direction, it handles a bandwidth well above 1,000,000 cycles, hence could be used to transmit one detailed television program between linked transmitters

Freed Manufacturing Formed

NEW YORK—The Freed Manufacturing Company, Inc., has been formed, will specialize in small superhets and t.r.f. sets covering both the broadcast and shortwave bands. J. D. R. Freed is president, Arthur Freed vice-president and general sales manager, Max Epstein treasurer and Samuel Glick secretary. Headquarters are to be at 127 West 17th Street.

A-K Out With Metal Tubes

PHILADELPHIA—Shipments of new metal-tubed Atwater Kent models began going forward July 15, we are advised by the factory. Plant officials state that all distributors will have quantities within a matter of days. No difficulty is anticipated in maintaining a steady flow of shipments to dealers as company plants are now in full production and can meet all reasonable demands.

The new line features "control room reception," a phrase coined to better describe high-fidelity to laymen.

Gov't Shortwave Book

WASHINGTON — The Department of Commerce, Bureau of Foreign and Domestic Commerce, has just announced publication of a 138 page book telling all there is to know about the wavelengths, operating schedules and power of all shortwave broadcast stations in this and other countries. It includes data on the best time to listen, useful distance and direction maps. Entitled "World Short-Wave Radiophone Transmitters." Costs 25 cents. An extremely useful work for the shortwave set-selling dealer and his most ardent dx-ing customers.

Show for Western N. Y.

ROCHESTER, N. Y.—The City of Rochester is staging a "Silver Anniversary" exposition (and Monroe County livestock show) from September 2 to 7. The local section of the IRSM plans to sponsor a simultaneous radio convention and exhibit, which will occupy part of the available exposition building.

Address Bertram L. Lewis, 89 East Ave., for information relative to booth costs.

Muter Expands Plant

CHICAGO—The "Little Ajax" interference eliminator has, we understand, worked wonders for The Muter Company's business. So much so, in fact, that the firm has doubled its floor space at 12th and Michigan, is installing new machinery to step up production.

Tung-Sol Plant Expands

NEWARK—Tung-Sol Radio Tubes, Inc., has just purchased a 5-story building at 370 Orange Street and will shortly manufacture here as well as at the existing plant located at Eighth Avenue.

GENERAL  ELECTRIC
RADIO
WILL DOMINATE THE

DETROIT MARKET



Through The
GENERAL ELECTRIC SUPPLY CORP.
WHOLESALE DISTRIBUTORS

of General Electric Appliances

Headquarters Detroit, Mich.
Branches Grand Rapids, Mich.
" Kalamazoo, Mich.
" Lansing, Mich.

Says C. D. LaMee, Manager, Appliance Sales:—

"As dramatic and sound as the new metal tube is the merchandising program for the new General Electric Radio line. General Electric Radio dealers this year have the opportunity of serving their communities with the finest line of receivers ever developed — truly a product of the 'House of Magic'. We look forward with enthusiasm to the day on which we will be able to announce this dramatic program to our dealers."



YOUR CUSTOMERS WILL PREFER
GENERAL  ELECTRIC
RADIO

With the tube that's "Sealed in Steel!"

GENERAL  ELECTRIC

**RADIO
WILL DOMINATE THE**

HARTFORD MARKET

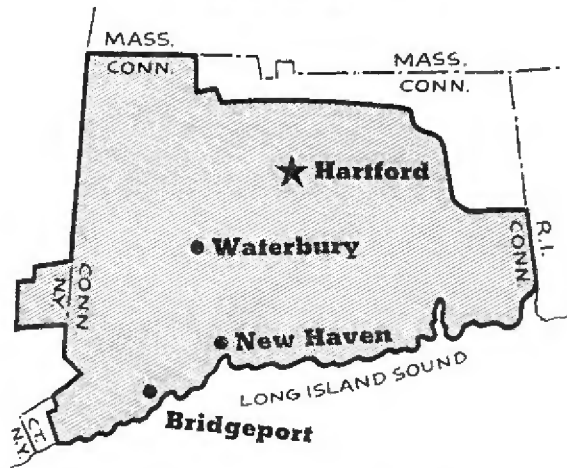

**Through The
GENERAL ELECTRIC SUPPLY CORP.
WHOLESALE DISTRIBUTORS**
of General Electric Appliances

Headquarters . . . Hartford, Conn.
Branches . . . New Haven, Conn.
" . . . Waterbury, Conn.
" . . . Bridgeport, Conn.

Says R. L. Hanks, Manager, Appliance Sales:—

"If careful planning in all the divisions of manufacturing, engineering production, and distribution, mean anything in ultimate success, we have them all in the new General Electric Radio program. Add to this a startling development like the metal tube, and it's 'in the bag'."



**YOUR CUSTOMERS WILL PREFER
GENERAL  ELECTRIC
RADIO**

With the tube that's "Sealed in Steel"

BANKRUPTCIES NEARLY CEASE

**Radio Industry In Better Shape,
Says Dun & Bradstreet**

NEW YORK—The total number of failures of radio manufacturers, wholesalers and retailers rated by Dun & Bradstreet, Inc., was reduced to 46 in 1934, according to this company. This is the fewest number of failures recorded in the industry's history. It was lower by 65.7 per cent than 1933, lower by 82.1 per cent than the all time high reached in 1930, when 257 companies departed this world.

During the first four months of 1935 only 2 failures have occurred among listed manufacturers, 19 among wholesalers and retailers. A complete tabulation of industry failures by years, with their liabilities, follows:

Manufacturers		
1930	40	\$3,522,400
1931	15	4,088,445
1932	23	1,826,996
1933	25	3,719,519
1934	9	941,338
1935*	2	45,000

Wholesalers, Retailers		
1930	217	\$2,071,392
1931	160	4,979,359
1932	170	1,978,678
1933	109	1,813,980
1934	37	2,207,408
1935*	19	152,432

*January to April, inclusive.

Jules Clothing Store to Handle Radio Sets

NEW YORK—Effective July 15, the Jules Chain Stores Corp. operating 40 retail outlets in the East, will feature radio sets in the popular price brackets. Henry Goldsmith has been engaged as radio buyer and manager. Mr. Goldsmith started with the Charles Freshman Co.

12 years ago. Has had four years experience with Ludwig Bauman and three years with the D. W. May organization.

The Jules headquarters address is 315 Fourth Avenue, New York City.

Allied Engineering Denies Federal Charge

NEW YORK—Allied Engineering Institute has filed a complete denial of the charges filed by the Federal Trade Commission, reported in last month's issue, with respect to the performance ability of this concern's product, the "Air Scout" set.

In its answer H. G. Cisin, general manager, claims that this receiver is in all truth an "all wave" product, even though priced at \$8.50.

Radio Retailing would point out that the filing of charges by the Commission should not be construed as in any way indicative of the truth or falsity of the allegations therein made.

Shelvador Sales Gain

CINCINNATI—Crosley Shelvador refrigerator sales gained 47.9 per cent in the first five months of the current year over the last, the manufacturer announces.



New Southern Service Association Heads

After much chasing up and down corridors at the Whitley, scene of the Southern District Radio Servicemen's Association convention at Montgomery, Ala., in June, the managing editor of "Radio Retailing" succeeded in corraling newly elected officers long enough to shoot this picture. Left to right, they are: John M. Fowler of Birmingham, vice-president; E. H. Olsen of Galveston, president, and L. W. Hopkins of Nashville, secretary-treasurer.

Metal Tube List Prices Announced

Initial list prices on the new metal tubes will be approximately double those on corresponding types with glass envelopes.

Following is the schedule announced by the Ken-Rad Corporation, Owensboro, Kentucky, effective July 1:

Type	Price	Description
5Z4	\$2.00	Full wave rectifier
6A8	2.00	Pentagrid converter
6C5	1.50	Detector amplifier triode
6F5	1.75	Hi-mu amplifier triode
6F6	1.75	Power amplifier pentode
6H6	1.50	Twin diode
6J7	1.75	Detector amplifier pentode
6K7	1.75	Super-control R.F. pentode
6L7	2.00	Pentagrid mixer amplifier

METAL TUBES



Direct-Mail Broadcast

Are the set boys plugging metal tubes for all they are worth? And how! Here's a reproduction of a penny post-card mailed to the trade by Grunow with a lavish hand.

Arcturus-Triumph Deal

NEWARK, N. J.—The Arcturus Radio Tube Company, this city, has just completed a deal with Triumph, maker of test equipment, which permits dealers and servicemen purchasing from the tube company to secure tube checkers, allwave signal generators and multi-range meters at low cost.

Grand Central Gets Eastern Exhibit

Prominent Radiomen Active In Promoting Fall Electrical and Radio Show

NEW YORK—Grand Central Palace, from September 18 to 28, will house the exhibits of the National Electrical and Radio Exposition, sponsored by the Electrical Association of New York. "The Hall of Science," a feature expected to attract thousands, will be widely advertised in the city's papers and over the air from the Exposition's own Crystal Studio.

Exhibits planned will include radio sets, accessories and parts, lighting, heating, refrigeration, air-conditioning, oil burners, domestic and industrial appliances. The Exposition committee includes the following well-known radiomen: Ben Abrams of Emerson, Tom O'Loughlin

of Philco, Ben Gross of Gross Sales, Irving Sarnoff of Bruno-New York and Ray V. Sutcliffe, Editor of "Radio Retailing."

Horton-Zenith Dealer Financing Plan

Illustrating the returning confidence which time payment contract purchase houses are feeling toward the radio retailer, was the announcement last month by the Walter E. Heller Company of favorable terms to Zenith dealers on radio paper. This plan was presented at the distributor convention of this Chicago radio concern.

Further, where the dealer handles Horton washing machines in conjunction with his set merchandising, interest rates will be lowered to meet those now prevailing on electrical appliance sales contracts.

Horton is doing its share to stimulate this joint merchandising activity. This Fort Wayne concern has just released a new type of newspaper advertising service for dealer local use. "A Short Course in Advertising" comes in the form of a portfolio of proofs and suggestions, "and make it easy for the dealer to get the personality of his own store, local policies and of the merchant himself into the advertising," according to W. T. White, general sales manager for Horton.

Austrian With Photophone

NEW YORK—Ralph B. Austrian, widely known in radio circles as, successively, assistant radio sales manager for Westinghouse, general sales manager for Kolster and general sales manager for Emerson, is now special representative for RCA Photophone, with headquarters at 411 Fifth Avenue.

Something we didn't know . . . Austrian was closely identified with the early beginnings of sound motion pictures when he served as assistant

GENERAL ELECTRIC
RADIO
WILL DOMINATE THE

KANSAS CITY MARKET

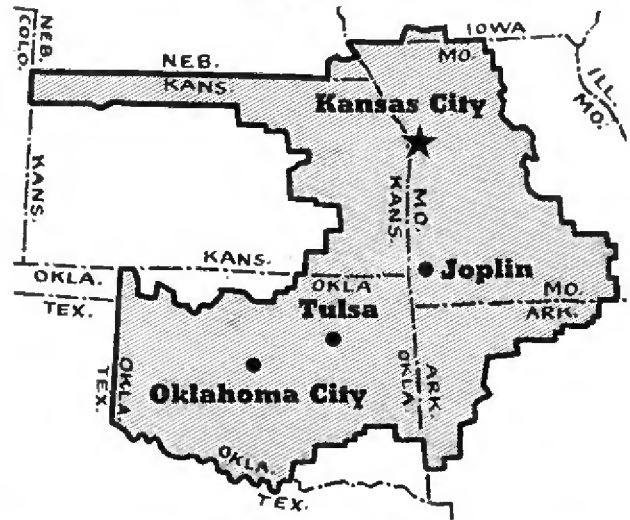

Through The
GENERAL ELECTRIC SUPPLY CORP.
WHOLESALE DISTRIBUTORS

of General Electric Appliances

Headquarters . . . Kansas City, Mo.
Branches Joplin, Mo.
" Oklahoma City, Okla.
" Tulsa, Okla.

Says M. J. Huie, Manager, Appliance Sales:—

"Now comes the rejuvenation of the radio market with the new and revolutionary line of General Electric Radio.

"Out of General Electric's 'House of Magic' have come the fundamentals of the radio industry. Now, out of that same realm of Science have come new developments; new features revolutionizing the entire industry, of which the new metal tube is only ONE.

"We will help you to sales with profits."



YOUR CUSTOMERS WILL PREFER
GENERAL ELECTRIC
RADIO

With the tube that's "Sealed in Steel"

GENERAL ELECTRIC
RADIO
WILL DOMINATE THE

LANCASTER
MARKET

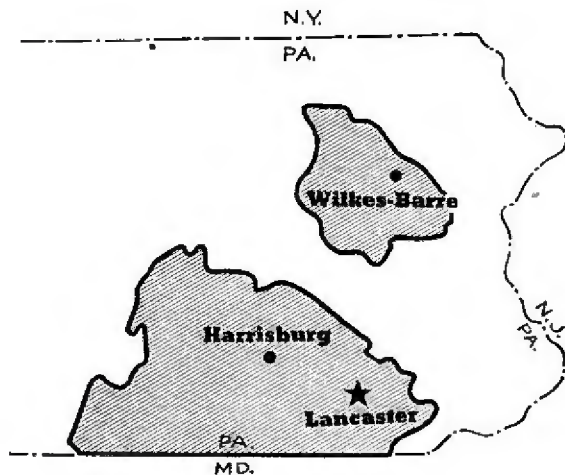

Through The
RAUB SUPPLY CO.
WHOLESALE DISTRIBUTORS

Headquarters . . . Lancaster, Pa.
Branches . . . Harrisburg, Pa.
" . . . Wilkes-Barre, Pa.

Says G. H. Hartman, Sales Manager:—

"All eyes are on the 'House of Magic', and General Electric Radio again comes through with the most startling news in the industry. We enthusiastically await the day we may be able to carry the big announcement to our many dealer friends. We'll be seeing you."



YOUR CUSTOMERS WILL PREFER
GENERAL ELECTRIC
RADIO
With the tube that's "Sealed in Steel"

sound supervisor over at the Paramount lot in Astoria some years ago. This experience should stand him in good stead when he contacts motion picture producers and theatre circuit operators in the East in behalf of High Fidelity sound systems made by The Corporation.

JOBBER GOSSIP

RCA Victor Distributing Corp. is the new name of the New York Talking Machine Company, Buffalo. President H. P. Fillmore points out that the old monicker, while widely known, was scarcely descriptive.

H. E. Sorenson Company of 912 Locust, Des Moines, has taken on Atwater Kent, is shouting from the housetops about the line's metal tubes and other attractive features. H. E. himself, active in the business since 1922, apparently got a kick out of the manufacturers' recent Atlantic City convention, took the line for all of Iowa. He already had Thor washers and ironers, Stewart Warner refrigerators, Servel and Friedrich equipment.

'34 Exports, \$23,766,323

WASHINGTON—In a bulletin just released by the U. S. Department of Commerce total exports of American receiving equipment (Alaska, Hawaii and Porto Rico excluded) is placed at \$23,766,323 for the year 1934.

There were 612,084 receivers exported, dollar values \$15,338,143; 6,682,083 tubes at \$3,209,946; \$4,358,827 worth of parts; 144,768 speakers at \$360,954 and \$498,453 worth of other receiving set accessories.

The Department has broken down these totals by countries, included the breakdown in Statement Number 2901.

Northeastern Radio of 181 Ann, Hartford, now has Horton washers and ironers. The outfit has a large radio dealer following by virtue of its 12-year activity in behalf of Zenith sets, recent Motorola and parts selling. Headquarters are in Boston but Horton merchandise will not be stocked there, distribution being confined to the Hartford territory. Congrats on the new line to manager Fleischman of the branch.

Deweese Joins Stewart-Warner

CHICAGO—C. C. Dewees, formerly associated with Grigsby-Grunow, Wurlitzer and the Dearborn Ad Agency, has been made assistant advertising manager for Stewart-Warner, where he will relieve advertising manager Fred R. Cross of much of the work associated with the company's radio and refrigeration departments.

Pierce Phelps of Philly is boosting refrigerator sales through the formation of a club in which retail salesmen handling boxes distributed by the firm are eligible. Prizes of tie-clasps, money clasps and rings are awarded to "high-men" and, in addition, the club keeps a complete record of its members' activities in the sales field . . . a valuable reference when men seek new jobs.

New Fada Agency

LONG ISLAND CITY — Fada Radio and Electric Corp., Long Island City, N. Y., has engaged the well known firm of Kelly, Nason and Roosevelt, New York City, to act as its advertising counsel. By so doing it again secures the services of Harry J. Winsten as account executive. Mr. Winsten directed the publicity policies of Fada in the "old days" during the period of its greatest success. From now on it is assured that the Fada name will be very much in the limelight.

The Shield Company, distributing Crosley products, has opened a new branch in El Paso, Texas, with A. S. Douglas in charge. Headquarters at Fort Worth.

Roycraft of the twin-cities pulled 425 radio dealers to a meeting at the Radisson Inn on Christmas Lake on June 10, wined, dined them, showed all and sundry the new Philco line.

Consolidated Wire Grows

CHICAGO—The Consolidated Wire & Associated Corporations, 512 South Peoria Street, reports taking over additional floor space, says operations are now at full capacity and plenty of back-orders on hand to warrant expansion.

Walter D. Ament of St. Louis has taken on the Girard-Hopkins line of condensers, travelling Missouri, Kansas, Nebraska, Iowa and Illinois. Stanley K. Wallace of Lutz, Florida, now handles the line in his own State, Georgia, Alabama and Mississippi.

En Route

By RVS

Hopped an airliner at New York, June 9, outward bound for Chicago—with intention of spending a few quiet days at RMA convention. Stayed two weeks at the Stevens. Found mid-west set makers seething with optimism and full of plans for going to town this season. Windy City parts companies busy as bees, filling orders for early delivery.

Bond Geddes figured on 200 at the RMA banquet, at \$5 a head. Actually, over 300 clamored for admission. This, the only social or get-together event of the "convention," shows that the old spirit still thrives. We're a sociable outfit. What the Radio Industry needs next year is a real opportunity to get together, count noses, get rid of our pet peeves and have a good time.

A number of the parts makers in New York and Chicago, think the RMA "ain't done right by Our Nell." Les Muter, himself a parts manufacturer and reelected to guide the destinies of the Radio Manufacturers Association for another year, is working on this.

Told me by a big tube maker: "Our engineer says the metal tube is a headache. But our production manager is enthusiastic. Likes the uniform and close tolerances of the "fernico" casing. Makes for accurate and rapid assembly. Uniform dimensions mean uniform performance characteristics. Hence a "balanced" set of tubes in every radio.

A Milwaukee jobber shed more light on this feature. "Evenly matched tubes make for greater amplification," he stated. "Un-matched tubes will lower the final stage as much as 40 per cent."

By the way, "fernico" gets its name from the chemical symbols of the three metal components amalgamated in this new casing: iron (fer), nickel (ni) and cobalt (co). The coefficient of expansion of this mixture is the same as that of glass—hence no leakage when the two are fused.

The much-touted "telegraph your service calls" campaign has evidently stirred up quite a ruckus among organized servicemen. Some may approve, feeling that the publicity given repair-men by Boake Carter will help all, but it has apparently been our fortune so far to attend only meetings where sentiment ran rather high against the plan. Repairmen, it seems, think that the doling out of business by jobbers must inevitably result in some distribution of calls to a favored few. Where sentiment

runs in this direction Philco jobbers appear to be letting Philadelphia do all the shouting, while they remain non-committally in the shadow. Several service organizations have wired headquarters: "Thanks for the offer of help. But if it's all the same to you we'd rather do our own selling."

Zenith has gone battery set minded in a big way. Also air-minded. The latter accounts for the former. "Charge your storage battery with air power and forget upkeep." This outfit has stopped mail order (Sears-Montgomery) competition dead in its tracks by a most attractive price—factory to user—on an air-power charger.

Orchids also to National Carbon, whose dealers are protected against the onslaughts of the catalog houses when it comes to cutting prices on Aircell batteries.

Belmont and Howard, well known Chicago set concerns, are setting their caps for jobber-dealer business. Coming out with new lines and policies which will surely attract the unattached tradesman.

Another evidence of this "New Era" of radio activity is seen in Fada's strong comeback. "Automatic Tone Regulation" for weak signals from distant stations is one of the many features of its new line. Will use the new metal tubes. "Tell your readers that our sets are designed from the ground up to fit in with the new characteristics of these tubes. As such we notice a decided improvement in their tone over any glass tube product on the market," president Marks.

Zenith, for the time being, is on top of the fence with its "Metaglass" tube. One guess as to what this name means.

Attended the "Old Guard" luncheon for RMA past presidents. Was introduced as an authority on television. In a few well chosen words disclaimed this honor but did mention that I heard a rumor that

(Please turn to page 39)

GENERAL  ELECTRIC

RADIO

WILL DOMINATE THE

LOS ANGELES MARKET

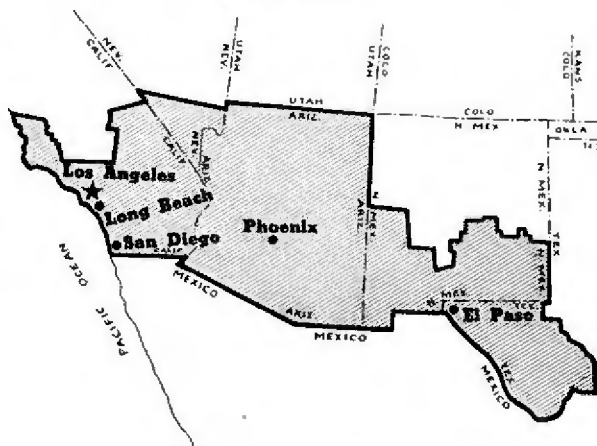

Through The
GENERAL ELECTRIC SUPPLY CORP.
WHOLESALE DISTRIBUTORS
of General Electric Appliances

Headquarters . . . Los Angeles, Calif.
Branches El Paso, Tex.
" **Phoenix, Ariz.**
" **San Diego, Calif.**
" **Long Beach, Calif.**

Says F. C. Todt, District Manager:—

"The entire Los Angeles territory is eagerly awaiting General Electric's big radio announcement. We will shortly be in a position to carry this story to you with all the drama and enthusiasm it warrants. Watch for the date of our announcement meeting."



YOUR CUSTOMERS WILL PREFER
GENERAL  ELECTRIC
RADIO

With the tube that's "Sealed in Steel"

A NATION-WIDE DISTRIBUTION
PREPARED TO SERVE THOSE RADIO DEALERS WHO BELIEVE IN



STABILIZ

"with the tube fl

UTING ORGANIZATION

THAT THE PUBLIC WILL PREFER GENERAL ELECTRIC RADIO



D RADIO

sealed in steel"



**GENERAL  ELECTRIC
RADIO
WILL DOMINATE THE**

**NEW YORK
MARKET**



**Through The
GENERAL ELECTRIC
SUPPLY CORP.
WHOLESALE
DISTRIBUTORS**
of General Electric
Appliances

- | | | |
|---------------------|-------|---------------------------|
| Headquarters | • • • | New York, N. Y. |
| Branches | • • • | Newark, N. J. |
| " | • • • | Bronx, N. Y. |
| " | • • • | Brooklyn, N. Y. |
| " | • • • | Jersey City, N. J. |
| " | • • • | Paterson, N. J. |

Says H. C. Calahan, District Manager:—

"Mr. Wygant and I have had an insight into the merchandising plans for General Electric Radio. We can truthfully state to you, based on years of association with the dealers, and having, we believe, a very definite knowledge as to your requirements and desires, that General Electric Radio now offers to you more of those desirable merchandising and profit features than have ever previously been made available to you by any manufacturer. Join with us for a profitable year."



**YOUR CUSTOMERS WILL PREFER
GENERAL  ELECTRIC
RADIO**

With the tube that's "Sealed in Steel"

Standardize your radio production with these Stackpole auto radio specialties

Thousands of auto radio sets, now in use, need the improvement of these Stackpole Specialties. They assure smoother and more perfect auto radio reception, give better tone control and eliminate ignition interference.

**Stackpole Carbon Auto Spark Suppressors
Eliminate Ignition Interference**

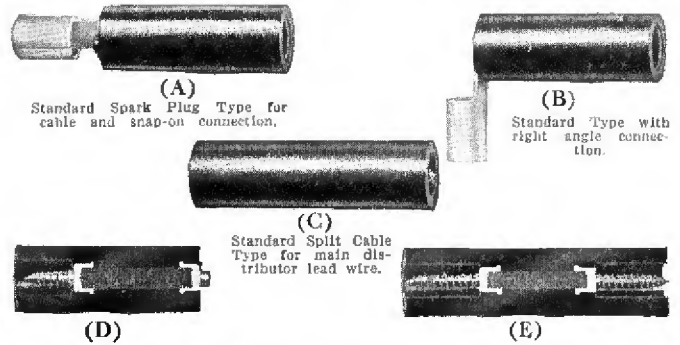

Designed especially to effectively suppress the high voltage discharge of automobile ignition on any car. Stackpole Suppressors consist of a resistor unit molded into a bakelite housing with connections molded into the bakelite at the same time . . . assures a solid, unified structure unaffected by heat, high humidity, vibration or rough usage. Direct electrical contact made from terminal to resistor element, eliminating troublesome steel wool and springs. Note cuts D and E above. Standard units have resistance value of 5,000, 10,000 and 20,000 ohms.

**The new STACKPOLE improved
paper type RADIO VOLUME
and TONE CONTROL**

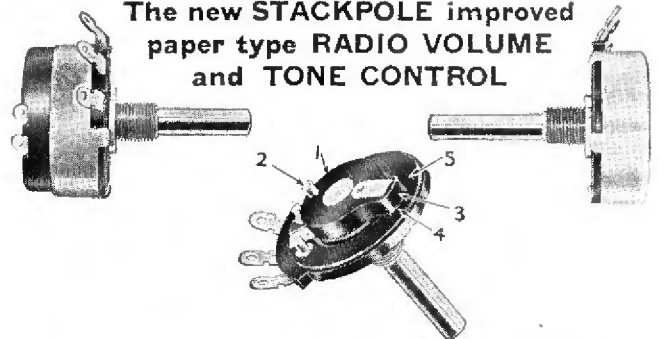

1. The Bakelite hub, which carries the contact, fully insulates the moving contact and resistance element from bushing and shaft . . . very necessary in a great number of applications.
2. The Switch-Operating cam is fastened directly to the bakelite hub and therefore, fully insulated from the resistance element.
3. Uniform contact pressure is maintained by a specially designed coil spring carried within the bakelite hub—always maintains the correct contact pressure.
4. The newly designed contact maintains a true line contact with the resistance element, thus eliminating any possibility of noise due to contact resistance.
5. New type "P" resistance element made by depositing carbon on high grade paper. Element is fired at high temperature making it permanent and unaffected by changes of humidity and temperature.

STACKPOLE FIXED MOLDED CARBON RESISTORS

Non-inductive . . . unaffected by humidity . . . the standard of comparison in the radio and electrical fields . . . designed for voltage reducers, cathode bias resistors, grid leaks and suppressors, tube plate loads and all radio and audio circuits.

Write for descriptive catalogue

STACKPOLE CARBON COMPANY

★ ★ ★ ST. MARYS, PA. ★ ★ ★

18-inch television was in successful operation in Montreal. On the other hand a technical writer proved recently by mathematics that acceptable television is practically impossible. Television is not "just around the corner." *Calm yourself as far as its slowing up of set sales is concerned.*

Last month Andrew Cruse, head of the radio division of the U. S. Department of Commerce, was in my office just prior to taking a ship for England, France and Germany. Purpose, to investigate the status of television in these countries—all under government supervision and subsidy. I told him television would have to be subsidized by our government if it is to have nationwide use and suggested that he report fully to President Roosevelt the result of his findings and endeavor to get a government appropriation of part of the 4.8 now available for public projects.

Henry Bonfig, sales manager for General Household Utilities (Grunow) has set July 22 as the date for his distributor convention. Promises a number of innovations "almost startling in their nature." Some kind fairy has been going around injecting a shot of adrenalin into the arms of set engineers.

How can the p.a. manufacturer who makes a quality product induce the radio dealer and serviceman to sell quality rather than price? This is one of the toughest problems facing manufacturers, particularly acute in the amplification field. The technical education of the men in the field is one way. It was also suggested that it may now be possible to measure and to show visually by means of the oscillograph comparative performances of receivers or of p.a. equipment.

An advertising agency executive told me that his personal survey of the servicing situation in South Bend, Ind., showed that those averaging the highest number of service calls per week invariably read RR.

Among the newer distributors at the Zenith shindig were Ben Oppenheim, of B & O Radio, Inc., Newark, N. J., and Ray Thomas, who came all the way from Los Angeles. Both play a nifty game of bridge, as the writer can testify.

1936 will be slogan year. In Stromberg Carlson sets its "clover-leaf" arrangement of coils and range switch. GE's neat assembly clears through a "sentry box."

It seems that a certain set manufacturer who is also avid for

replacement parts business is applying pressure (delicately, mind you) to his jobbers, requesting that they concentrate on the one brand of parts to the complete exclusion of others. Where such jobbers rely mainly on this manufacturer's sets for their livelihood it is rather difficult to refuse, so many are swallowing their feelings and so doing. This is opening gaps in the distribution setup of independent parts makers and new distributor appointments are envisioned. Unless the one line of parts referred to is pretty much favored by servicemen there is apt to be quite a change in leadership in a number of territories before the end of the year. Some combination set and parts distributors hitherto big shots in their own home town are going down. And others free to pick and choose their own lines are coming up.

New York and Boston jobbers journeyed to GE party under motorcycle police escorts. Some fun!

Was granted a peek at the new line of Fairbanks-Morse receivers. Cabinet designs as striking and pleasing as any my untutored taste has yet witnessed.

Won a free lunch shaking dice with Frank Gruesel (Grunow jobber, Milwaukee). Frank heads the "only live radio dealer-distributor trade association in these United States." Will run a radio show this fall in the city that made beer famous.

Tom Blackburn has been appointed chief cameraman and scribe to represent *Radio Retailing* in the Middle West. His address is McGraw-Hill Building, 520 North Michigan Ave., Chicago.

This month will mark the wind-up of most of the fall announcement conventions. Howard, F-M, Grunow, Bosch and many others pulling presentations prior to August 1.

Atwater Kent will start its second decade of radio concerts in September.

Stromberg's for Streamlined Trains

ROCHESTER—The Chicago, Burlington and Quincy Railroad, operator of the widely-publicized "Zephyr," has just purchased its fourth Stromberg-Carlson sound system for installation in the "Mark Twain," new streamlined flyer soon to join the fleet operating between Chicago and the Twin Cities.

GENERAL  ELECTRIC
RADIO
WILL DOMINATE THE

NEW YORK MARKET



Through The
ROYAL EASTERN
ELECTRICAL SUPPLY CO.
WHOLESALE DISTRIBUTORS

Headquarters . . . New York, N. Y.
Branches Brooklyn, N. Y.
" . . . **Long Island City, N. Y.**
" . . . **New Rochelle, N. Y.**

Says S. D. Goodman, General Sales Manager:—

"If a maiden ever had a prayer — here's the answer! General Electric offers to the retailer a set designed by G.E. — engineered by G.E. — made by G.E. A promotional and advertising campaign laid out to satisfy even the expectations of a metropolitan dealer. The franchise will be the most valuable in the radio industry because it has the fundamental requirements of an ideal set-up for everyone participating in this profitable sales picture. The greatest sensation in radio since 1929. It's a natural!"



YOUR CUSTOMERS WILL PREFER
GENERAL  ELECTRIC
RADIO

With the tube that's "Sealed in Steel"

**GENERAL  ELECTRIC
RADIO
WILL DOMINATE THE**

**OMAHA
MARKET**

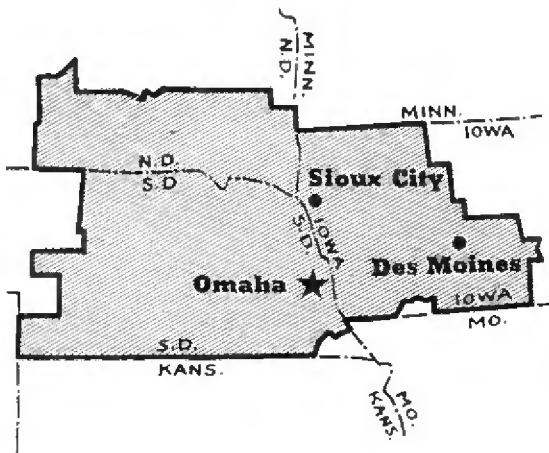

**Through The
GENERAL ELECTRIC SUPPLY CORP.
WHOLESALE DISTRIBUTORS**
of General Electric Appliances

Headquarters Omaha, Nebr.
Branches Des Moines, Ia.
. Sioux City, Ia.

Says G. W. Clark, District Manager:—

"Direct from the 'House of Magic' has come the new General Electric Bridgeport-manufactured radio receivers. They far surpass anything I have ever seen or heard."

"Competitive price range, outstanding design, superior construction, complete sales plan, national advertising schedules, dealer cooperative advertising, and sales promotion helps, make the 1936 General Electric Radio Franchise the most valuable ever offered by any manufacturer. Franchises are being closed rapidly. Write now for details."



**YOUR CUSTOMERS WILL PREFER
GENERAL  ELECTRIC
RADIO**

With the tube that's "Sealed in Steel"

**ERIE
RESISTORS**

UNIFORM!

Millions of Erie Resistors are contributing to the efficient operation of the country's most popular radio receivers. These products have a recognized reputation for uniformity, order after order and can be depended on for all-round balanced performance.

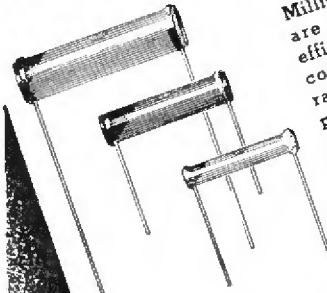

ADAPTABLE!

The new 1/4 watt Erie Insulated Resistors are meeting with enthusiastic praise everywhere. Complete ceramic insulation plus small size, makes installation possible in the smallest spaces without "shorts" or "grounds".

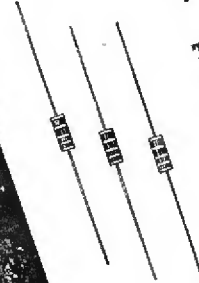

EFFICIENT!

Because they have low voltage coefficient, Erie Suppressors are highly effective at sufficiently low resistance values not to noticeably affect motor operation. Approved by over 34 car manufacturers and used by leading manufacturers of auto radio sets.

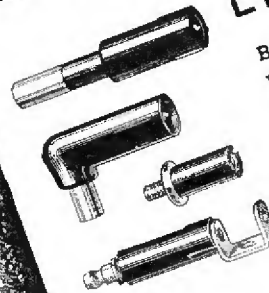

ERIE RESISTOR CORPORATION, ERIE, PA.

**ERIE
SUPPRESSORS**

Managing Manpower

(Continued from page 15)

record and the branch manager's report whether or not he fits. If he does he is definitely and permanently "in." If not, he is just as permanently "out."

DEVELOPMENT

Here are some of the things salesmen are taught. Many of them will be familiar, sound merchandising principles known to any Main Street dealer but they are not ordinarily expected of a chain:

When a man walks into the store he is considered a customer, not a "mooch." The salesman treats him as one, right from the tap of the gong, making every possible effort to sell even though the man appears to be a window shopper. This, we submit, is the right attitude, one which materially aids any sale.

After sets are demonstrated and every effort has been made to close there may come a time when the customer freezes up and won't make a decision. At this crucial point, and we think this is clever, the chain's men are instructed to always ASK HIM TO BUY. "A request to buy is much better than floundering around for a new point of attack," says the manager. "Most people are accustomed to taking orders from someone and when asked, practically *told*, to buy, react favorably if anywhere near boiling point. I have frequently worked a prospect up to fever heat and had him balk at the last minute. At this time I point to his pocket and say firmly "Give me a \$5 deposit on this radio right now and we will have it playing in your home tonight." Most men involuntarily reach for their wallet. Some have even taken it out and partially extracted a bill before catching themselves sheepishly in the act of purchasing when they had not actually decided to take the plunge.

"Selling talk should not be avoided. Softness in this respect is a general weakness of salesmen. Tell your story, then when fairly certain that the prospect is interested but hesitates to sign on the dotted line say buy, buy, buy in every way you know how to say it."

Do you take a man's order, rise quickly with an expression of relief, say "thank you" and give him the air, considering your work done? It is bad practice to terminate a sale so quickly, according to this chain, and has a detrimental effect on business. The store manager is always introduced to the customer after he has completed his purchase. This has a double purpose. The customer loses the impression that he has been "sold"; he leaves the store with the feeling that he has "bought." In addition, it gives the manager another chance to sell up.

Why do millionaires, important in their own right, strike up acquaintance with second-rate "pugs," then take considerable pleasure in basking in the reflected glory by introducing these fighters to friends? They need not sun themselves in anyone's reflected glory, and yet they do. So do radio buyers. Introduced to the store manager they feel flattered, frequently bring in others to meet their friend, "the manager of the biggest radio store in town."

Introducing the manager is called "T-O'ing." Usually the manager compliments the buyer on his selection, makes him feel that the purchase was wise. "It's the best set in the store," he tells the purchaser confidentially. The probability of dissatisfaction is thus mate-

(Please turn to page 52)

GENERAL ELECTRIC

RADIO

WILL DOMINATE THE

PITTSBURGH

MARKET

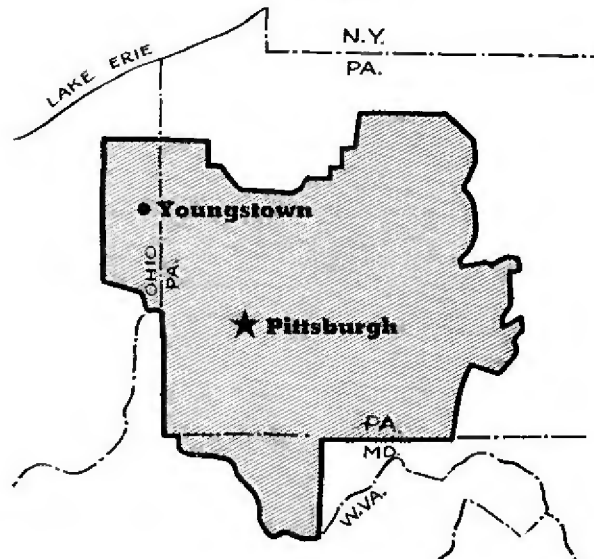

Through The

GENERAL ELECTRIC SUPPLY CORP.

WHOLESALE DISTRIBUTORS

of General Electric Appliances

Headquarters . . . **Pittsburgh, Pa.**

Branch . . . **Youngstown, O.**

Says R. M. Davis, Manager, Appliance Sales:—

"It is with a spirit of enthusiasm that we advise Bridgeport that we are ready to accomplish a radio selling job never before attained on General Electric Radio. For the first time in the radio business, we are fortified with a complete new line of radios manufactured at Bridgeport, possessing innovations and improvements which are bound to find public acceptance. G-E Radio will be the best this year."



YOUR CUSTOMERS WILL PREFER

GENERAL ELECTRIC

RADIO

With the tube that's "Sealed in Steel"

**GENERAL  ELECTRIC
RADIO
WILL DOMINATE THE**

**PORTLAND
MARKET**

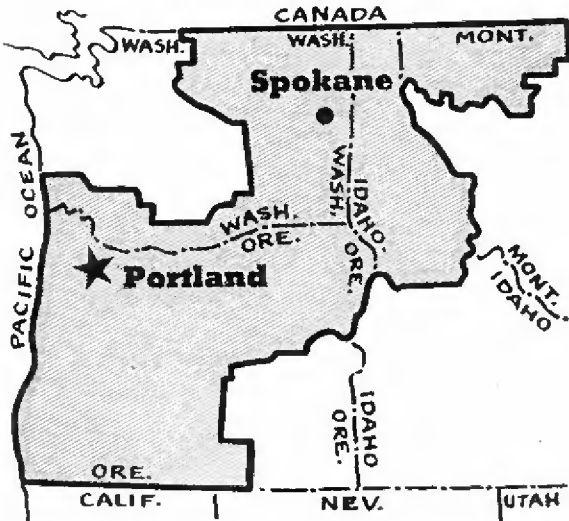

**Through The
GENERAL ELECTRIC SUPPLY CORP.
WHOLESALE DISTRIBUTORS**
of General Electric Appliances

**Headquarters . . . Portland, Ore.
Branch . . . Spokane, Wash.**

Says G. A. Boring, District Manager:—

"We consider the profitable exploitation of the new General Electric Radio line a three-way association in which the parties are our dealers, the General Electric Company and ourselves — all joined in a gigantic program for profitable sales. And supported by the plans coming out of Bridgeport, we know we are headed for the top."



**YOUR CUSTOMERS WILL PREFER
GENERAL  ELECTRIC
RADIO**
With the tube that's "Sealed in Steel"

Announcing . . .

**● COMPLETE LINE
NEW AND IMPROVED**

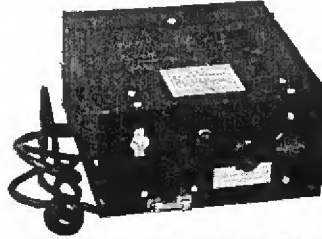

**ATR
DC-AC
INVERTERS**

For operating Standard A.C. Radios, Public Address Systems, fans, vacuum cleaners, mixers, hair dryers, curling irons, medical appliances, etc. In CARS . . . On FARMS . . . and in D.C. Districts. **Interference-free** all-wave radio reception assured!!!

**PROVEN-DEPENDABLE
GUARANTEED**

ATR DC-AC Inverters are simple, easy to use, inexpensive devices for producing 110 volt alternating current from 6 volt storage batteries, 32 volt farm plants, and 110 volt D.C. systems. No need to purchase special appliances. ATR DC-AC Inverters will supply 110 volt A.C. power for operating standard A.C. devices.

List Price
\$18.50*

Specify type desired.
Standard Discounts Apply.

Type	D.C. Input	A.C. Output	Maximum Cap.	List Price
6	6 volts	110 V. 50-60 cycles	50 watts	\$18.50
32	32 volts	110 V. 50-60 cycles	100 watts	18.50
110	110 volts	110 V. 50-60 cycles	200 watts	18.50

* Without radio filter—\$22.50, with built-in filter; External filter unit for inverters (not so equipped), \$5.95.
Inverter types for various D.C. inputs, and 110 and 220 A.C. outputs, are also available.

Write or Wire for additional information
Sold by Leading Jobbers everywhere

AMERICAN TELEVISION & RADIO CO.
St. Paul, Minnesota, U.S.A.—Cable Address: "LIKEX" N. Y.

**GE . . .
Congratulations!**

We are proud and gratified that your engineers, who should know insulating materials if anyone does, have selected Lavolain.

We are certain this super quality insulating porcelain will perform to your complete satisfaction.

STAR PORCELAIN COMPANY
TRENTON, N. J.



**Ken-Rad
Radio Tubes**
DEPENDABLE LONG LIFE

Ken-Rad Radio Tubes are made to give clear, dependable reception. They satisfy customers and build good will for dealers. Write for full information.

THE KEN-RAD CORPORATION, Inc., Owensboro, Ky.
*Division of The Ken-Rad Tube and Lamp Corporation
Also Mfrs. of Ken-Rad Incandescent Electric Lamps*

NEW MERCHANDISE

NOISE REDUCING ANTENNAS

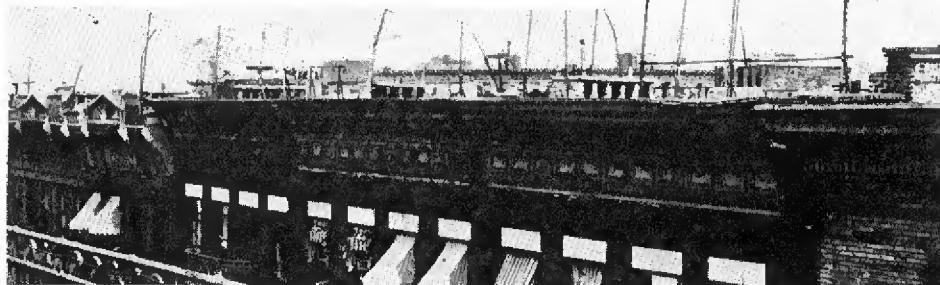

Here's what happens to the skyline when each set owner puts up his own "garden variety" of antenna

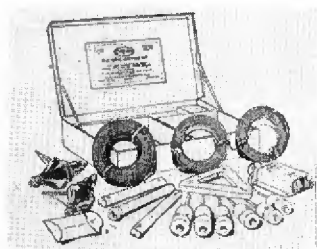

"Brownie" All-Wave Antenna

A fundamental balanced double antenna using a transposed lead-in, which terminates in a universal impedance matching transformer is offered by Porcelain Products, Inc., Findlay, Ohio, under the name "Brownie." The antenna proper is 66 ft. long broken in the exact center by a porcelain junction block, thus giving two spans of 33 ft. each. This length was selected after exhaustive field tests whereby it was proved, Porcelain engineers say, that an antenna with a fundamental frequency of 7,000 kc. gives the greatest overall gain from 500 kc. to 15 mc.

The lead-in is an efficient transposed line having no metallic shielding and thus offering the least capacitive reactance. The length of the lead-in is exactly 75 ft., providing a perfect balance for the antenna proper. The length of this lead-in can be increased by additional 75 ft. lengths until 300 ft. is reached, after which further length of lead-in is not recommended owing to impairment of efficiency.

The universal impedance matching transformer is so constructed that any radio can be matched to the transmission line. The secondary side of this matching transformer is provided with three take-off points. This company also makes a "Three Star" all-wave antenna for both short and long wave reception. It is of the balanced doublet design with all essential parts except the matching transformer. \$3.—*Radio Retailing*, July, 1935.

Antennas

American Radio Hardware Co., Inc., 133 Grand St., New York City, makes many things of interest to service men.

First there is a telescoping

transceiver antenna of the vertical type made of specially gauged hard aluminum. Each section has specially designed force locking devices for locking the two different size tubings in position. The half-wave type of vertical antenna is so constructed that by adjusting the telescoping rods it is possible to work on the $\frac{1}{2}$ wave as well. Price range: \$2.50 to \$20.

This company also makes insulated antenna and feed spreaders; insulated tapered type standoffs; a box containing complete hardware for short-wave, television and radio sets, \$1.60; a serviceman's kit listing at \$4.50; a testing kit, \$2; insulated solderless test prods. It also makes two other antennas: a $2\frac{1}{2}$ and 5 meter doublet antenna and an all-direction antenna for all-wave use.—*Radio Retailing*, July, 1935.

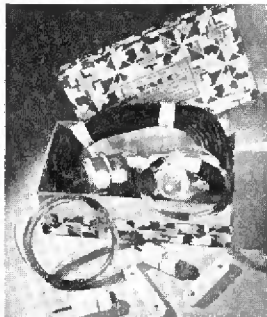

Taco Antenna Kit

The No. 20 noise-reducing all-wave antenna system of the Technical Appliance Corp., 27-26 Jackson Ave., Long Island City, N. Y., consists of an upper transformer house in a weatherproof aluminum shell. The aerial wires are soldered to terminals and are 30 ft. in length on each side of transformer. Seventy-five feet of twisted pair weatherproof transmission line is supplied. The set coupler, also encased in a weatherproof aluminum shell, is equipped with screw binding posts on a bakelite panel. The coupler is fully automatic and the usual manual switching is accomplished by means of an electrical hook-up between the high frequency transformers and the standard broadcast transformers.

All accessories to make the complete installation are included and the price is \$6.75.—*Radio Retailing*, July, 1935.

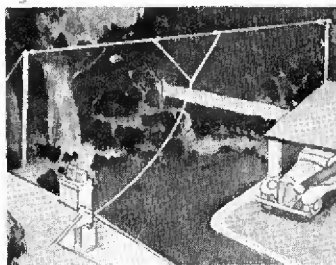

GE V-Doublet Antenna

The newly designed "V-Doublet" antenna system developed by the General Electric Co., Bridgeport, Conn., differs from the elementary doublet which, it is said, tends to favor certain frequencies and reject others. The "V-Doublet" is coupled to the transmission line by the converging "V." This makes the doublet respond uniformly to a wider range of shortwave signals and the "V" matches the doublet more perfectly to the transmission line so that the signal transfer is smooth, the bulletin states. This is explained as follows: At the top where the spacing is wide the characteristic impedance is high and comparable to that of the doublet; at the bottom where the wires are close together, it is low to match the low impedance of the transmission line.

This design lends itself to various methods of suspension and is simple to install.—*Radio Retailing*, July, 1935.

Johnson "Dual-Doublet" Antenna

A doublet antenna for use with broadcast, shortwave or all-wave sets is available from E. F. Johnson Co., Waseca, Minn. It is composed of a "flat top" section of two equal halves, insulated where they meet at the center, plus a two-wire transposed lead-in to the receiver. Transposition is accomplished by means of the specially designed No. 31 transposition insulator.

The 320A kit containing 20 No. 31 transposition insulators, 8 No. 32 airplane insulators and 200 ft. No. 14 enameled copper wire is \$4.75.—*Radio Retailing*, July, 1935.

Belden All-Wave System

After an extensive study of the elements necessary in the construction of an efficient noise reducing antenna system for all-wave reception the Belden Mfg. Co., 4689 W. Van Buren St., Chicago, announces its 8917 doublet antenna system. While it is primarily intended for short-wave reception, it makes the doublet type aerial suitable for broadcast receivers.

The unit is pre-assembled, both arms of the aerial being securely soldered to the doublet lead-in at the triangular transposition block. Insulators are attached and corrected lengths are provided to give most efficient service with the variable all-wave receiver antenna coupler which is included with the set. This unit eliminates the need for double or multiple span antennas which occupy large areas and are hard to install.

The same equipment is also furnished unattached in Belden No. 8918 aerial kit for those who prefer to make the complete assembly themselves.—*Radio Retailing*, July, 1935.



Zenith Doublet Antenna

The long distance all-wave doublet antenna system of the Zenith Radio Corp., 3620 Iron St., Chicago, has been designed to improve reception of foreign shortwave broadcast stations and at the same time reduce man-made electrical disturbances. Physical and electrical constants of this antenna were determined after extensive measurements and comparative air tests under actual reception conditions.

The system comprises essentially an antenna and counterpoise, two lead-in wires and a transformer which couples this line to the set. Electrically it has been designed to eliminate "dead spots" on shortwaves and at the same time reduce noise over this range as well as the standard band.—*Radio Retailing*, July, 1935.

GENERAL  ELECTRIC
RADIO
WILL DOMINATE THE

PHILADELPHIA
MARKET

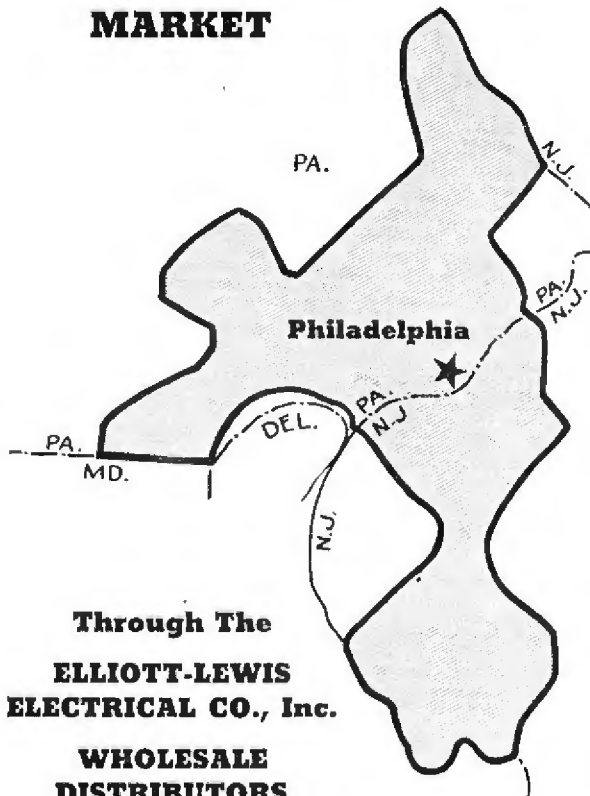

Through The
ELLIOTT-LEWIS
ELECTRICAL CO., Inc.
WHOLESALE
DISTRIBUTORS

Headquarters . . . Philadelphia, Pa.

Says F. R. Elliott, President:—

"In all my thirty years in the electrical industry, I have never seen the equal of this General Electric Radio program. A merchandising program that will attract prospects into your store, and merchandise that will sell on sight are an unbeatable combination.

"We have been preparing for this program for more than a year. Whether it be assistance in actual retail sales, problems in merchandising, or service, we are prepared to give our dealers whatever individual assistance they require."



YOUR CUSTOMERS WILL PREFER
GENERAL  ELECTRIC
RADIO
With the tube that's "Sealed in Steel"

"Noise Master" Antenna

Complete elimination of "man-made" static on broadcast as well as shortwave bands is provided by its "Noise Master" antenna unit, the Cornish Wire Co., 30 Church St., New York City, states. "Noise Master" permits operation of more than one set from one aerial. It lists for \$6.75, which includes two 40 ft. coils of 7/8 stranded enameled antenna wire, 1 upper transformer unit, 2 glass insulators, 50 ft. twisted pair down lead, 1 lower transformer unit, 1 No. 755 dual lead-in strip.

This kit is only one item in an extensive line of modern antenna units engineered by this company.—*Radio Retailing*, July, 1935.

MORE NEW

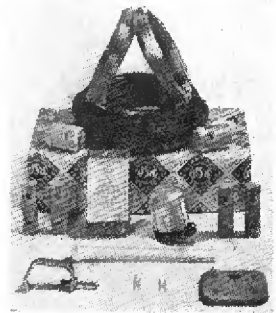

RCA Antenna Systems

The deluxe world-wide antenna kit of the RCA Mfg. Co., Inc., Camden, N. J., reduces noise on both standard and shortwave programs. It adapts itself to many types of installations to suit the location, \$7.75. A similar system with all the same advantages except the noise-reducing feature on domestic reception is \$6.

For amateurs, dealers and experimenters, who may prefer to buy their own standard parts, a kit of essential parts of the World-Wide system is provided. Contents: 1 roll transmission line (80 ft.), 1 receiver coupling transformer, 1 crossover insulator. Antenna wire, insulators, etc., may be purchased locally.

A World-Wide dealer demonstration system to handle up to 4 sets is also available, \$16.50. RCA's shielded antenna system for standard broadcast reception only is \$5.

For auto-radios, RCA makes a "noise reducer" antenna, just as effective in steel top cars as on other types. Ignition noises cannot enter the set through this antenna, the folder states. Mounting brackets, for attaching under running board, may be adjusted for different heights and moved horizontally along arms of the antenna to fit each car.

For cars which have no built-in antenna or when factory installed job does not give satisfaction, there is a roof antenna which comes in tan or gray and lists at \$1.50.—*Radio Retailing*, July, 1935.



Browning Universal Allwave Antenna Kit

The Browning Universal all-wave antenna kit is designed for use in any type of location. It may be used as a doublet antenna with a total top spread of 75 ft. using 3 1/2 ft. on either side of the junction block, or, in a limited space, it may be used with a total top spread of 41 ft. using 20 1/2 ft. on either side of the junction block. These two lengths match the couplers supplied with the kit. 75 ft. of transposed weatherproof transmission lead-in is supplied. Switching arrangement for use on the coupler for broadcast bands from 200 to 500 meters. Comes complete with doublet lightning arrester and accessories. Rivard Mfg. Co., 1014 Madison Ave., Toledo, Ohio.—*Radio Retailing*, July, 1935.



AK Doublet Antenna Kit

Type D (No. 28076) doublet antenna kit manufactured by the Atwater Kent Mfg. Co., Philadelphia, Pa., consists of a simple doublet with a parallel transmission line. To permit the use of this antenna (\$3.95) with all-wave and shortwave sets equipped with a regular single antenna connection, a special transformer (\$2.50) has been developed. This transformer is equipped with a changeover switch allowing a doublet antenna to be used as a regular single antenna when the regular broadcast band of the receiver is being tuned.—*Radio Retailing*, July, 1935.

Ajax Antenna System

The Ajax all-wave antenna system made by the Philmore Mfg. Co., Inc., 113 University Place, New York City, consists of the newly designed Navy type insulators, center insulators, all-wave coupler and transmission cable. The center insulator prevents the transmission line from breaking as the loop at the center permits a safe anchorage and removes the strain on it. The all-wave coupler does not require a switching device for reception of broadcast and shortwave stations. \$4.50.

Philmore also offers another all-wave antenna system consisting of a doublet antenna with a twisted pair transmission line terminating in an all-wave coupler. \$4.50.

Two aerial kits are included in the line as well. Kit No. 1 has 100 ft. of 7-24 stranded copper aerial wire, 25 ft. rubber covered lead-in wire, 25 ft. bell wire and hardware. \$1.35. Kit No. 2 has 75 ft. 7-26 stranded copper aerial wire, 25 ft. rubber covered lead-in wire and hardware. \$1.—*Radio Retailing*, July, 1935.

MERCHANDISE

Brach "Pur-A-Tone" Doublet Antenna Kit

All necessary parts for a complete doublet antenna with twisted wire transmission line are contained in the new "Pur-A-Tone" all-wave aerial kit of L. S. Brach Mfg. Corp., Newark, N. J. The kit comprises 60 ft. bare antenna wire, 50 ft. stranded rubber-covered twisted and braided downlead, antenna coupler, receiver coupler and necessary hardware. \$6.75.

Brach also makes other doublet and non-doublet antenna kits ranging in price from \$1.95 to \$3.35.—*Radio Retailing*, July, 1935.

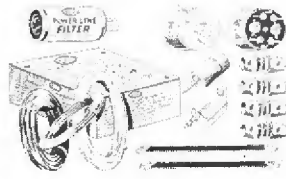

Tobe Allwave Antenna System

The new system of the Tobe Deutschmann Corp., Canton, Mass., is universal in nature—can be erected as either an ordinary flat top-aerial for which the time of installation is very short or as a half-wave Hertz doublet where cost of installation is not as vital a factor.

The system makes use of an antenna transformer to match the impedance of the flat top to that of the transmission line, 50 ft. of twisted pair lead-in wire and a receiver transformer to match the impedance of the lead-in to that of the input to the receiver. For good matching on all frequencies a pair of toggle switches are incorporated on the receiver transformer which cut into the circuit different portions of the transformer windings. Thus, maximum signal strength is assured at all frequencies.

It is available in two kits: one designed for the dealer who buys antenna wire and hardware in bulk lots and desire only the basic units (2 transformers and transmission wire), \$4.95; and the other for the dealer who prefers to sell the customer the complete aerial system in one box, \$6.95.—*Radio Retailing*, July, 1935.

"Red Head" Auto Antenna

The "Red Head" non-directional antenna of the Victory Mfg. and Distributing Co., 3104 Michigan Ave., Chicago, Ill., is designed to fit and operate under the running board. Many new cars have holes drilled in the running board braces for the mounting of this type of antenna. The perforated brackets furnished with the "Red Head" may be fastened to the car in several ways. This antenna will not rattle. \$2.75.—*Radio Retailing*, July, 1935.

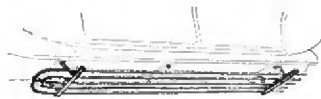

Radolek Antenna System

If installed with the short leads at right angles to the long leads, the new double-doublet antenna system of the Radolek Co., 601 W. Randolph St., Chicago, Ill., will counteract the usual directional characteristic of this type antenna, it is claimed. To further improve operation, a dual set of matching impedances are employed, one at each end of the lead-in. The coupler at the receiver end contains a balanced circuit with a center tapped impedance, capacity coupled to the radio so that the system acts like a giant umbrella aerial on broadcasts between 550 and 1,800 kc. and as an unidirectional double-doublet in the high frequency bands.—*Radio Retailing*, July, 1935.

J. F. D. Auto Antenna

A directional antenna, the open end being mounted facing the front of the car so as to present as little noise pick-up surface to the engine as possible, is being made by the J. F. Distributing Co., 5204 Ft. Hamilton Parkway, Brooklyn, N. Y. Approximate size, 8x48 in. Tubular shape. The list price is \$1.65.—*Radio Retailing*, July, 1935.

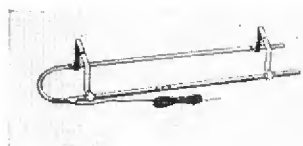

Lynch "No-Stat" Antenna System

The "No-Stat" broadcast antenna system of Arthur H. Lynch, Inc., 227 Fulton St., New York City, consists of a pair of impedance-matching transformers which allow the use of a shielded transmission line of any length without loss of signal strength, it is claimed. Its use preserves the purity of the (Please turn to page 46)

GENERAL ELECTRIC
RADIO
WILL DOMINATE THE

PHILADELPHIA
MARKET



Through The
GENERAL
ELECTRIC
SUPPLY CORP.
WHOLESALE
DISTRIBUTORS
of General Electric
Appliances

Headquarters . . . Philadelphia, Pa.
Branches Allentown, Pa.
" Scranton, Pa.
" Reading, Pa.

Says W. H. Coleman, District Manager:—

"Our entire sales organization and myself are pledged to bring to you the complete sales story of the new wonderful General Electric Radio.

"A General Electric Radio Merchandising program that will bring prospects to dealers' stores for quick sales.

"We are prepared to give assistance to dealers on their merchandising problems through our competent Radio Specialists. Get on this G-E Band Wagon."



YOUR CUSTOMERS WILL PREFER
GENERAL ELECTRIC
RADIO

With the tube that's "Sealed in Steel"

GENERAL  ELECTRIC

**RADIO
WILL DOMINATE THE**

**SALT LAKE CITY
MARKET**

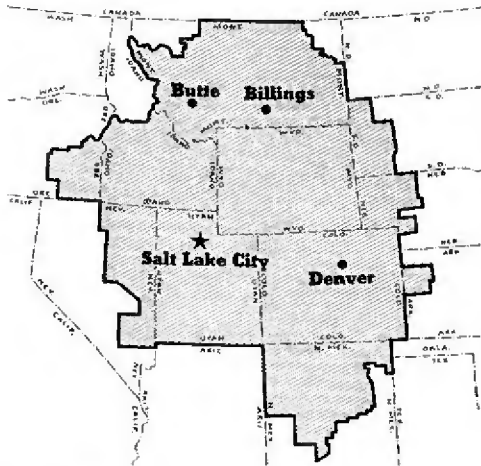

**Through The
GENERAL ELECTRIC SUPPLY CORP.
WHOLESALE DISTRIBUTORS**
of General Electric Appliances

Headquarters . . . Salt Lake City, Utah
Branches Billings, Mont.
" Butte, Mont.
" Denver, Colo.

Says J. A. Kahn, District Manager:—

"Greetings to all of our dealers who even before they knew anything of the new General Electric Radio line expressed such remarkable enthusiasm. I can assure you your enthusiasm will know no limits after you have seen these remarkable receivers from the 'House of Magic' — and that the great day will soon be here."



**YOUR CUSTOMERS WILL PREFER
GENERAL  ELECTRIC
RADIO**

With the tube that's "Sealed in Steel"

MORE NEW

signal interrupted by the lofty antenna and at the same time eliminates most of the crashes, growls and other noises commonly classed as man-made static. The complete kit consisting of 1 antenna impedance-matching transformer, 1 receiver impedance-matching transformer and 50 ft. of shielded transmission cable is \$5. With 75 ft. of cable the price is \$5.50 and with 100 ft. the list is \$6.

This antenna may be employed in combination with the Multicoupler Antenna System whereby two or more radio sets may be operated from one antenna.

Lyuch also makes a short-wave antenna system which includes 15 transposition blocks, 8 commercial type insulators, a doubler coupler and 200 ft. of enameled shortwave antenna wire, all priced at \$6.—*Radio Retailing*, July, 1935.

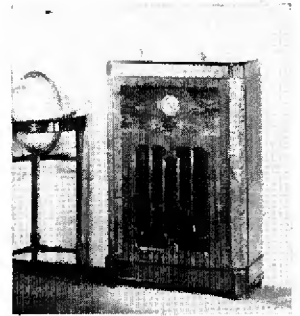

Stromberg-Carlson Model 58W

**Stromberg-Carlson
Radios**

Simultaneously with the announcement of an extension of its price range, the Stromberg-Carlson Telephone Mfg. Co., Rochester, N. Y., announces three new world ranging radio models. The new price range is from \$59.50 to \$985. New low price marks the lowest figure at which any Stromberg-Carlson radio has ever been available.

This \$59.50 set is known as the No. 58 T triple range table model. The other two models of the same series announced at this time are Models 58-L triple range standard lowboy and 58-W de luxe lowboy. They are priced at \$78.50 and \$92.50. All prices are for the East.

The operating units of all three are alike with the exception of the No. 58-W which has a 10 1/2 in. speaker as compared to the 8 1/2 in. speaker used in the other two.

Several new and unusual features are incorporated, the most

"Effarsee" Antennas

A shortwave double connection multiple coil antenna in which the coils are made to buck each other on untuned frequencies is only one of the many household and auto aeriels being made by the Fishwick Radio Co., 407 E. 8th St., Cincinnati, Ohio.

In its "concentrated" type of antenna, Fishwick claims to have equalled or excelled long wire antenna and in addition all types have proven noise reducing in relation to signal. One of the principal advantages of these aeriels is their simplicity of installation.

This company makes an under-car antenna consisting of 92 No. 30 copper wires, each 9 ft. long, which are imbedded in a waterproof insulation sheet 9 ft. long and 3 ft. wide. These wires are uniformly spaced 1/4 in. apart and are electrically "open" at both ends. One end of each of the antenna wires is capacitively coupled to the connecting wire of the radio by means of the "capacity coupling strip." There is no direct electrical connection between the antenna wires and the radio. This aerial comes in four models listing at from \$2.50 to \$4.95. Particularly recommended for turret tops, convertibles, coupes, roadsters, etc.—*Radio Retailing*, July, 1935.

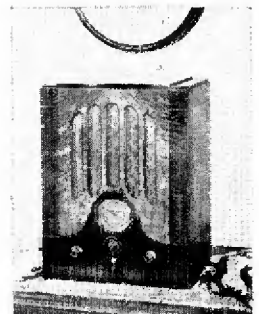

Stromberg-Carlson Model 58T



ICA Antennatrol

A new three-in-one accessory for radio receivers which functions as an antenna tuner, wave trap or aerial eliminator has been introduced under the name "Antennatrol" by the Insuline Corp., of America, 25 Park Place, New York City.

Consisting of a fixed condenser and a finely adjustable inductance, the Antennatrol adds a full tuned circuit to the receiver. When connected across the aerial and ground wires to act as an antenna tuner, it increases volume and improves the selectivity, the statement reads.

When connected directly in series with the aerial lead alone, it functions as wave trap.

As an aerial eliminator the Antennatrol permits the ground alone to be used for signal pick-up.—*Radio Retailing*, July, 1935.

outstanding of which is probably the "clover-leaf" arrangement of coils, aligning condensers and range switch. The three wave bands cover from 540 to 1500 kc., 1450 to 3500 kc. and 5600 to 18,000 kc.

Other performance and construction features are: Sensitivity and selectivity on all three bands exceptionally high; a.v.c. on all three tuning ranges; unusual undistorted sound output; freedom from disturbing cabinet "boom" avoided by using shallow designs of cabinets with ample venting.

The six tubes employed, which perform the functions of at least eight single purpose tubes, are 2-6D6, 6A7, 75, 42 and 80.

Model 58-T cabinet has a square corner effect to provide a clean cut and crisp outline.

Model 58-L lowboy is slightly higher and wider than the well known 60-L. It also has the square corner design.

Model 58-W wide lowboy console is considerably higher and wider than the 58-L.—*Radio Retailing*, July, 1935.

MERCHANDISE

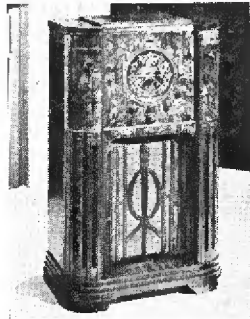

Zenith Model 12A-58

1936 Zenith Line

The 1936 line of receivers just brought out by Zenith Radio Corp., 3620 Iron St., Chicago, is distinguished by more than the usual number of special features. In fact, "talking" points was the keynote of the presentation in Chicago last month.

Attention is called to the very large, full faced dials. The black background with transparent white markings make an arresting appearance when illuminated from the rear by the red, green and blue lights, according to the dial in use. Split second tuning is to be had on all the better models. Overtone amplifier, the preliminary use of "Metaglass" tubes and a spe-

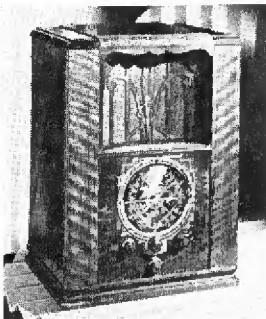

Zenith Model 6S-27

cial sounding board mounting for speaker are noteworthy features. A number of the sets have two speakers.

The 4 tube chassis may be had in either a table cabinet or modern console. 540-1640 and 1550-3700 kc. \$20 and \$39.95.

There are also two five tube models—table and console. 535-1520, 1460-4450 and 5800-18,500 kc. \$39.95 and \$59.95.

With six tube line up and tuning range of 5 wave bands on 3 simplified dial ranges covering 535-1520, 1460-4450 and 5800-18500 kc., the table set is \$59.95 and the console is \$69.95.

The two 7 tube receivers (550-1780, 2160-7000, 7000-23000 kc.) list at \$75 for the table set and \$89.95 for the console.

Two consoles and an upright table set may be had with the 9 tube chassis. These sets cover the same tuning range as the 7 tubers. They list at \$85 for the table model, \$99.95 for regular console and \$119.95 for the deluxe console.

Both 12 tube sets are consoles. \$139.95 and \$159.95 for the deluxe model.

The two 16 tube sets are "Stratosphere" models listing at \$375 and \$450.

The 25 tube ultra-modern, all-wave (63,600-535kc.) superhet is also retained. \$750.

Four farm sets are included

this year—a console and table style with either 4 or 6 tube chassis. All operate from 6 volt battery—no B or C batteries required. The smaller job covers from 550-1800 kc and the larger, 550-1780, 2100-7000 and 7000-23000 kc. The prices are: 4 tube table set, \$29.95, console, \$59.95; 6 tube table set, \$69.95, console, \$89.95.—*Radio Retailing*, July, 1935.

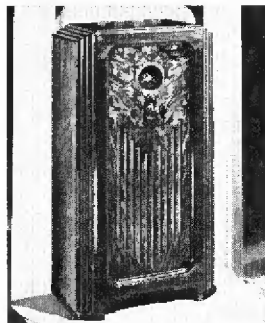

Zenith Model 5S-56

Pioneer "Air-Flo" Wind Powered Charger

A complete unit device, wind-powered and providing 6 volts and 5 amp. direct current to charge and keep charged the storage battery of a radio set or the battery of any 6-volt lighting system may be obtained from the Pioneer Gen-E-Motor Corp., 466 W. Superior St., Chicago, Ill.

The generator unit is completely water-tight and provided with cut-out device to operate when the battery is fully charged. The propeller is scientifically curved to get maximum r.p.m. at any wind velocity and to operate at extremely low wind velocity. The unit may be mounted directly on the roof or may be supported by a tower unit which is sold separately.

This charge is furnished complete with ammeter, cutout relay, pipe fittings, clamps, battery clips and sufficient wire for the average installation. The wind gear is \$26.95 and the tower \$6.50.—*Radio Retailing*, July, 1935.

Universal Recording Machine

A new professional recording machine has just been put on the market by the Universal Microphone Co., Inglewood, Calif. This assembly is completely mounted on cast iron castings and weighs 125 lb. with a turntable disc of 16 in.

A rim drive feature, which "steadies" recording, distinguishes the model from earlier non-professional types of machines. The motor is of the constant speed type, not self starting, 110 volts a.c.

Other recording lines of Universal include a recording amplifier, a smaller disc recorder No. 12, full frequency pick-up, power recorder, recording condenser microphone, tube to cutting head transformer, lead screws, aluminum blanks and Silveroid discs, together with cactus, sapphire, bamboo and trailing shoe needles.—*Radio Retailing*, July, 1935.

GENERAL ELECTRIC
RADIO
WILL DOMINATE THE

ST. LOUIS MARKET

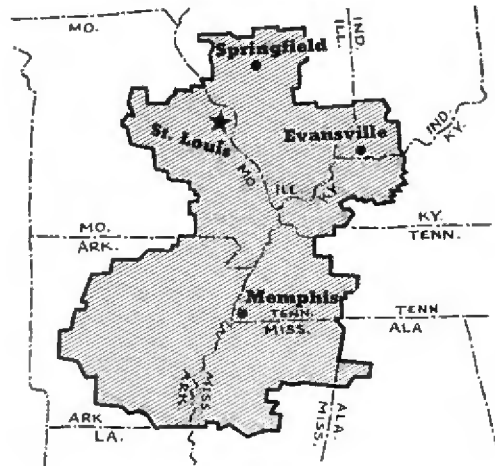

Through The
GENERAL ELECTRIC SUPPLY CORP.
WHOLESALE DISTRIBUTORS

of General Electric Appliances

Headquarters St. Louis, Mo.
Branches Evansville, Ind.
" **Memphis, Tenn.**
" **Springfield, Ill.**

Says L. C. Arnold, District Manager:—

"Great things are immediately ahead for General Electric Radio dealers. Formal announcement of the new General Electric Receivers will be forthcoming shortly and to the progressive dealers in the St. Louis district who secure a franchise we predict a most successful season. Do not be satisfied any longer with just ordinary radio merchandise. Decide now that you want to be the leading dealer in your community. Plans and date of our dealer meeting will be released in a few days. Prepare now to be on hand and hear this most important message."



YOUR CUSTOMERS WILL PREFER
GENERAL ELECTRIC
RADIO

With the tube that's "Sealed in Steel"

GENERAL ELECTRIC
RADIO
WILL DOMINATE THE

ST. PAUL
MARKET

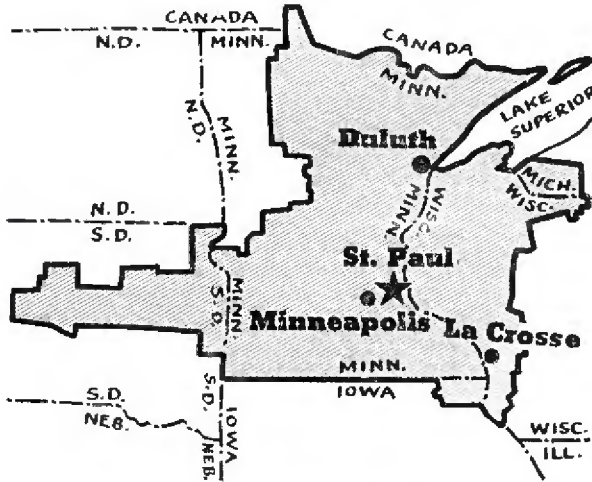

Through The
GENERAL ELECTRIC SUPPLY CORP.
WHOLESALE DISTRIBUTORS
of General Electric Appliances

Headquarters St. Paul, Minn.
Branches Duluth, Minn.
" Minneapolis, Minn.
" La Crosse, Wis.

Says L. C. Mample, District Manager:—

"In my opinion General Electric offers the most valuable exclusive franchise ever offered by any manufacturer. I urge radio dealers in our territory to act now by identifying themselves with this new and highly desirable product of the 'House of Magic'.
 "The line has quality; attractiveness of design; competitive price range; a vast national advertising schedule; dealer co-operative advertising and sales promotion helps. All are backed by General Electric resources, engineering ability, and the inexhaustible 'House of Magic' research facilities.
 "My advice is — WRITE TODAY FOR FRANCHISE DETAILS."



YOUR CUSTOMERS WILL PREFER
GENERAL ELECTRIC
RADIO
With the tube that's "Sealed in Steel"

MORE NEW

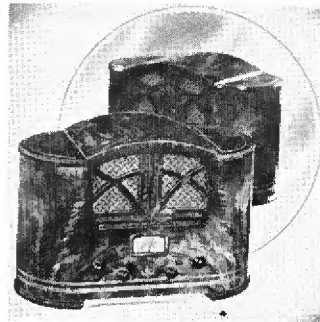

Emerson Model

New Emerson Line

A most unusual and distinctive set is included in the 1936 line just announced by the Emerson Radio and Phonograph Co., 111 Eighth Ave., New York City. This is a "double-face" walnut table model which may be used on a library table, for example, where both sides of the set would be exposed. The back is designed and finished the same as the front, as shown in the illustration which contains a mirror so that both sides may be seen. This is a 6 tube, three band, Round-the-World superhet using three metal tubes. \$44.95. Four other ac-dc compacts are

one 4½ v. and one 16½ v. C-battery. \$34.95.
 Model 34-F7 is a 7 tube, Round-the-World table set and Model 101-F7 incorporates the same chassis in a console case.
 Among the highlights of the new Emerson line this year are: telegraphic interference trap to filter out code signals, capacitive filter to protect against man-made electrical interference; color matched illuminated dials, shock mounted variable condensers, mechanical band spread tuning with dual-speed knob, phonograph jack pick-up, Cadalite plated (rust proof) chassis.
 —Radio Retailing, July, 1935.

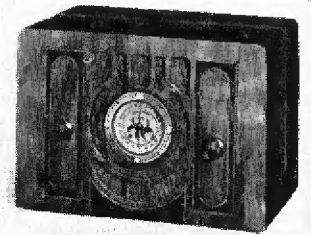

Freed Eismann Model H357P

A two band, ac-dc superhet is now ready at the new offices of the Freed Mfg. Co., Inc. at 127 W. 17th St., New York City. It is a 5 tube set using 6A7, 6D6, 76, 43 and 25Z5. Wavelength ranges: 85-200 and 200-500 meters. This set has a full vision airplane dial with the broadcast scale calibrated in kilocycles and the shortwave band in meters with indicating markers to show location of police cuts. — Radio Retailing, July, 1935.



Emerson Model 105

ready. A 4-tube in bakelite case, \$15; a 5 tube, dual-wave set, \$25 in bakelite case and \$30 in walnut; and a 6 tube dual-wave set using 2 metal tubes, \$35.

Three a.c. midsets are also offered: Model 38, an upright table set, 5 tubes, 95-550 meters, \$20; Model 34C a 6 tube, Round-the-World superhet with 4 metal tubes, \$44.95; and Model 104, 8 tube all-wave receiver employing 6 metal tubes, \$69.95.

Model 101U is a 6 tube, ac-dc, three band, Round-the-World console with 3 metal tubes, \$69.95.

In the a.c. console line there are Model 101, 6 tubes, Round-the-World, \$59.95; Model 102, 8 tube, all-wave, 6 metal tubes, \$89.95 and Model 105 a 11 tube all-wave, high fidelity superhet employing 10 metal tubes, \$109.95.

For the farm market, which is developing so rapidly, Emerson offers three battery receivers—two table models and a console. Model 103 is a 5 tube, (and ballast lamp) dual-wave super covering from 200-500 and 75-200 meters. Easily converted for use with any desired battery equipment. Following batteries are required: for filament supply (any one of the following)—2 v. storage battery, 2½ v. Aircell, 3 v. dry-cell pack or 6 v. storage battery; high voltage —135 v. of B-batteries; bias—

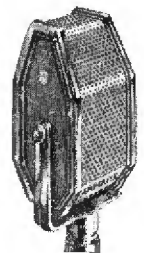

Amperite High Impedance Velocity Mike

Retaining such features as natural reproduction without peaks and the elimination of feedback, the new high impedance velocity microphone of the Amperite Corp., 561 Broadway, New York City, has the added feature of operating directly into the grid, meaning the elimination of the input transformer and the elimination of the pre-amplifier with amplifiers having a gain of 100 db. or more. The high impedance microphone can be fed directly into the photo-electric cell jack of "talky" amplifiers without any circuit changes. Condenser and crystal microphones can also be replaced in a similar manner. Another advantage is that ordinary carbon volume controls can be used as mixers. —Radio Retailing, July, 1935.

MERCHANDISE

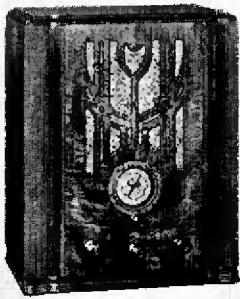

Fada Model 160T

1936 Fada Line

Twelve of the sixteen sets in the line just announced by the Fada Radio and Electric Co., Long Island City, N. Y., have metal tubes. The price range is from \$19.99 to \$144.50.

Among the features incorporated in the metal tube sets are automatic tone regulation, which minimizes interstation noises and makes tone on distant domestic and shortwave stations



Fada Model 170C and 170CK

comparable with nearby local stations and "split second tuning dial" for accurate tuning of foreign as well as local stations. This device gives stop watch accuracy of tuning and enables the user to correctly log stations. Another highlight is "noise suppression volume control" that controls both sensitivity and volume and not only minimizes interstation noises but reduces noises on strong stations when the set is used in obstinate reception locations.

High fidelity reproducers are available on the metal tube con-

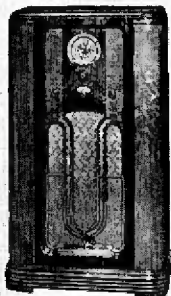

Fada Model 192C and 192CK

soles. Both audio systems and reproducers are designed to give a frequency response with uniformity well beyond the limits of present broadcast stations.

Fada cabinets are designed to meet the 1936 mode and are not only modern in style but so designed to minimize undesirable cabinet vibration.

Briefly, the line includes: three a.c.-d.c. portables, \$19.99, \$32.95 (metal tubes) and \$39.95; three nine tube a.c.-d.c. deluxe models, all with metal tubes, \$72.50 for the table set, and \$99.95 and \$124.75 for the consoles, the latter a high fidelity model; two a.c. sets using glass tubes, \$39.95 for the 5 tube table receiver and \$59.95 for the console, both world wide reception.

The a.c. all metal tube models comprise the following: Models 160T and 160C, table and console, 6 tube world-wide sets, \$52.95 and \$69.95; Models 170T and 170C, 7 tube world-wide table and console, \$62.95 and \$82.95; Model 170CK, 7 tube world-wide high fidelity console, \$99.95; Model 190T and 190C, 9 tube all-wave table and console, \$84.50 and \$124.50 and Model 190CK, 9 tube all-wave high fidelity console, \$144.50.—*Radio Retailing*, July, 1935.

Sprague Interference Analyzer

The prompt location and elimination of all types of radio interference is possible with the interference analyzer introduced by the Sprague Products Co., North Adams, Mass. It also affords an easy and inexpensive means of demonstrating to set owners just where and how annoying interference originates.

The analyzer is a compact, professional instrument, 4 1/2 x 7 x 3 in., contained in a sturdy Bakelite case. With it the serviceman can tell exactly what condensers or chokes are needed to eliminate noise from small appliance motors, oil burners, traffic lights, physicians' appliances and a host of other causes of static. By connecting the analyzer into the circuit, he can show the customer how interference may be eliminated by use of the proper filtering equipment.—*Radio Retailing*, July, 1935.

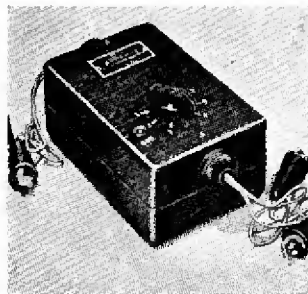

Ward Leonard Replacement Resistors

A line of replacement resistors is announced by the Ward Leonard Elec. Co., Mount Vernon, N. Y.

These resistors have a screw on the band which permits adjustment of the resistance to the desired value. Potentiometer connections may be obtained by using end terminals and band connections. The vitreous enamel, covering most of the unit, provides protection against mechanical damage and prevents the wire from shifting. They come in 25, 50, 100, 160 and 200 watt sizes, 1 to 150,000 ohms.—*Radio Retailing*, July, 1935.

GENERAL  ELECTRIC

RADIO
WILL DOMINATE THE

WASHINGTON
MARKET

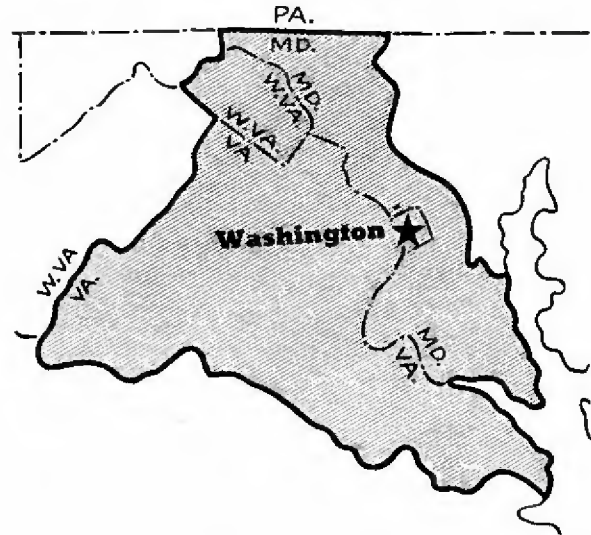

Through The
NATIONAL ELECTRICAL SUPPLY CO.
WHOLESALE DISTRIBUTORS

Headquarters . . . Washington, D. C.

Says F. N. Chase, Mgr., Radio & Marine Dept.:—

"I cannot help but feel that the distributor who is handling the General Electric Radio line this year is to be congratulated, for if I am any judge of the radio situation, we will set the pace this year in the radio business. There is no question but that we are going places and doing things with our 'three-way association'. I, for one, am proud to offer this opportunity to our dealers."

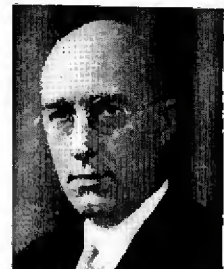

YOUR CUSTOMERS WILL PREFER
GENERAL  ELECTRIC
RADIO

With the tube that's "Sealed in Steel"

GENERAL  ELECTRIC
RADIO
WILL DOMINATE THE

SAN FRANCISCO
MARKET

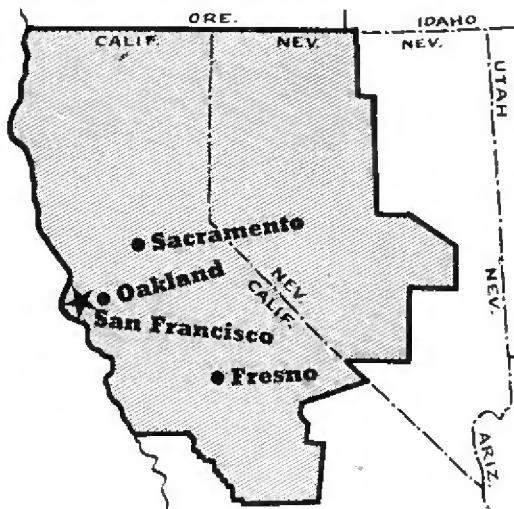

Through The
GENERAL ELECTRIC SUPPLY CORP.
WHOLESALE DISTRIBUTORS
of General Electric Appliances

Headquarters . . . San Francisco, Calif.
Branches . . . Sacramento, Calif.
" . . . Fresno, Calif.
" . . . Oakland, Calif.

Says D. E. Harris, Vice-President:—

"Born in the General Electric 'House of Magic' at Schenectady, N. Y.
Designed in the General Electric Radio Laboratory, Bridgeport, Conn.
Engineered in the General Electric Radio Laboratory, Bridgeport, Conn.
Manufactured in the General Electric Radio Factory, Bridgeport, Conn.
"The new General Electric Radio program cannot miss in California. Our entire organization is convinced that this is General Electric Radio's year."



YOUR CUSTOMERS WILL PREFER
GENERAL  ELECTRIC
RADIO

With the tube that's "Sealed in Steel"

MORE NEW

Arcturus Tubes With
"Metal Type" Base
and Glass Top

A new line of tubes has been developed and is being marketed by the Arcturus Radio Tube Co., Newark, N. J., designated as the "G" series. They are identical in electrical characteristics and pin connections to the all-metal tubes. It is stated that several set makers have already developed circuits employing these new "G" tubes.

Carrying the same type numbers as do the all-metal tubes, the letter G is suffixed to denote the glass envelope tube.

To date, the Arcturus G line comprises the following types: 6A8G, 6C5G, 6D5G, 6F5G, 6F6G, 6H6G, 6J7G, 6K7G, 6L7G and 5Y3.

These tubes are directly interchangeable with corresponding type number of all-metal tubes.—*Radio Retailing*, July, 1935.

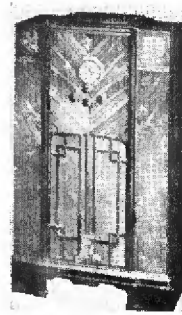

Garod Receivers

"Master Control" is utilized in the Model 511 table and console models which the Garod Radio Corp., 34 E. 12th St., New York City, has placed on the market. This master control unit is the heart-center of the receiver and months of research and development were spent in bringing this principle to a successful conclusion. The chassis used in these 2 sets takes 11 tubes and the speaker is a 10 inch high fidelity reproducer. For high fidelity, expanding selectors (XPS) are used to give ultra-sharp selectivity in the contracted position and opened up in the expanded position to freely admit the high frequencies. Covers 5 bands from 8 to 2050 meters.

Models 83, 83LW, 512, 73 and the 310 chassis also are equipped with master control.

In addition there are several other a.c. and ac-dc table and consoles in the line. All the large receivers are also available as phonograph-radio combinations.

Garod cabinets are designed along conservatively moderne lines and made of selected woods with satin finish.—*Radio Retailing*, July, 1935.

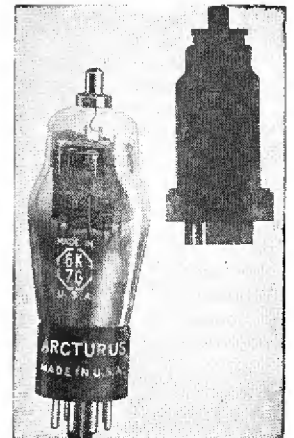

Muter Certified Resistance Bridge

To meet the demand, from both shop and laboratory, for an accurate Wheatstone type resistance bridge at a reasonable price, the Muter Co., 1255 S. Michigan Ave., Chicago, has designed the Certified Resistance Bridge to retail for about one-third the cost of other bridges of this type, the manufacturer claims.

The internal construction is of interest. The resistor elements are wound in strip form, the taps being set to an extreme degree of accuracy. Thorough vacuum impregnation insures freedom from variation due to changes in humidity. A special alloy resistance wire is employed to maintain constant resistance regardless of reasonable changes in temperature.—*Radio Retailing*, July, 1935.

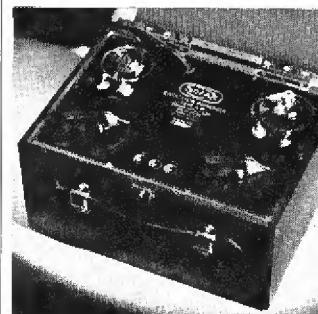

Solar Capacitor Analyzer

A well-built, accurate and easy-to-use capacitor analyzer is being made by the Solar Mfg. Corp., 599 Broadway, New York City. It measures capacity of all types of electrolytic, paper and mica condensers by means of built-in thermionically controlled Wien bridge, measures leakage, indicates dielectric resistance and can also be used as a continuity meter for testing all types of circuits.

Two dials provide complete condenser analyses quickly and all measurements are made simply and directly.

Supplied in an attractive cabinet with removable top. Weight, 7 lb. Dimensions, 9 1/2 x 7 1/2 x 6 1/2 in. It lists at \$28.90 including neon glow tubes but less the 53 and 80 types.—*Radio Retailing*, July, 1935.



Radio Retailing, July, 1935

MERCHANDISE

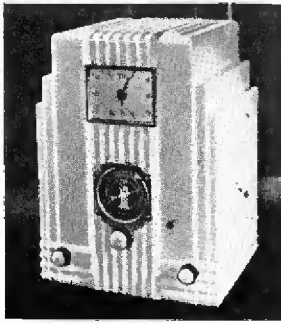

New Air King Set

A modernistic cabinet with a built-in modernistic electric clock make the Air King radio of the Air King Products Co. Inc., 27 Hooper St., Brooklyn, N. Y., a particularly attractive model. It is available in 13 colors including black, ivory, green, red, mother of pearl, walnut, mahogany, etc.

This is a 6 tube superhet covering 550-1650 and 5800-17,500 kc. The tubes used are 6A7, 6D6, 75, 43, 25Z5 and 340. \$49.50, complete.—*Radio Retailing*, July, 1935.

Thordarson "Foundation" Unit

Two service instruments combined in one "build-it-yourself" design is the feature of the Thordarson condenser capacity-leakage tester foundation unit. Recognizing the tendency of radio servicemen to build their own equipment, the Thordarson Electric Mfg. Co., 500 W. Huron St., Chicago, has produced a foundation unit consisting of a portable walnut instrument case, an etched and drilled metal panel with a scale calibrated in microfarads, matched panel mounting screws and complete instructions and assembly plans for a condenser capacity-leakage tester. Most of the additional parts required to complete this unit are stock items.

The completed unit will measure capacity between 0.001 to 50 mfd. and indicate leakage on a neon glow lamp. The capacity measuring portion operates from 105 to 120 volts, 60 cycles a.c. employing the Wheatstone bridge principle. \$4.50.—*Radio Retailing*, July, 1935.

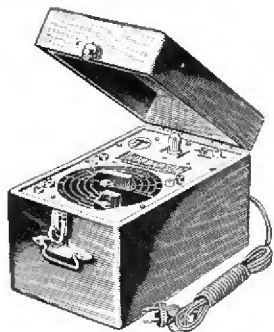

Eby Electric Eye

An electric eye has been developed by Hugh H. Eby, Inc., 2066 Hunting Park Ave., Philadelphia, Pa. This "eye," or photo electric cell of the electronic type, incorporates many

new features. It is available either singly, in complete assemblies containing cell, relay, tube, resistances, socket, etc., or in handy kits for home or laboratory experimentation.

This cell is moderately priced and of sturdy, simplified construction. It covers an unusually wide range, operates on either a.c. or d.c., has low internal capacity and has the distinct advantage of being sensitive in both the generative and emissive classes.—*Radio Retailing*, July, 1935.



Clough-Brengle Cathode-Ray Equipment

A number of new features are introduced in the new cathode-ray equipment for servicing radio receivers which has just been announced by the Clough-Brengle Co., 1134 W. Austin Ave., Chicago.

Among these is an entirely new sweep system that produces on the cathode ray tubes a receiver selectivity curve that is accurately calibrated and can be read directly in kilocycle width.

Another feature in receiver



servicing made possible is the feeding of an r.f. wave modulated by a 400 cycle sine wave into the receiver at antenna and ground and then observing the shape of the wave at the speaker voice coil, as pictured by the cathode-ray tube. This test will show overall receiver audio distortion, including such distortion as may occur in first detector, second detector, a.v.c. and audio stages. A complete cathode-ray visual radio servicer is composed of the model OM signal generator with built-in frequency modulator and the model CRA or model CRB oscilloscope.—*Radio Retailing*, July, 1935.

Philco Eyeletting Kit

A handy and convenient item for serviceman is the new eyeletting kit of the Philco Radio & Television Co., Philadelphia, Pa. This kit consists of an anvil, a punch and a liberal assortment of eyelets for use in fastening various parts, such as sockets, large condensers, etc. to the radio chassis. It is known as part No. 45-1162 and lists at \$5.—*Radio Retailing*, July, 1935.

GENERAL  ELECTRIC
RADIO
WILL DOMINATE THE

SEATTLE

MARKET

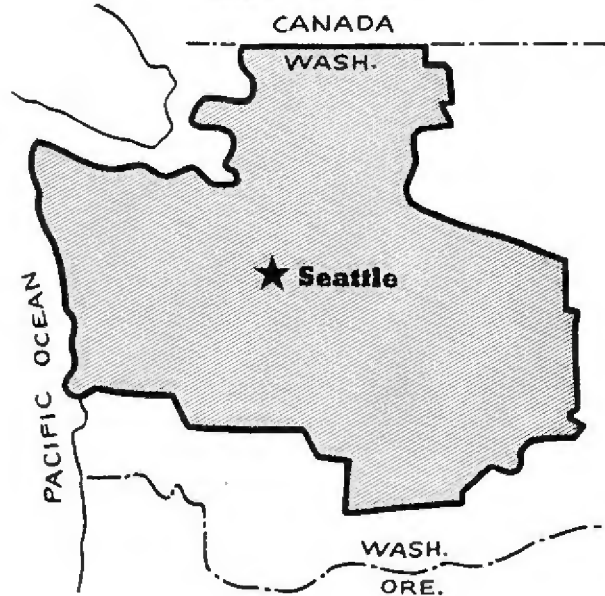

Through The
GENERAL ELECTRIC SUPPLY CORP.
WHOLESALE DISTRIBUTORS

of General Electric Appliances

Headquarters . . . Seattle, Wash.

Says F. A. Block, Manager, Appliance Sales:—

"The new General Electric Radio line will be:

"1—Designed beyond competition; 2—Priced competitively; 3—Promoted aggressively; 4—Available when season opens. These four essentials are adequately met in the new General Electric Radio Program. We are anxious to tell you more of it. Write for details."



YOUR CUSTOMERS WILL PREFER
GENERAL  ELECTRIC
RADIO

With the tube that's "Sealed in Steel"

GENERAL  ELECTRIC
RADIO
WILL DOMINATE THE

WICHITA
MARKET

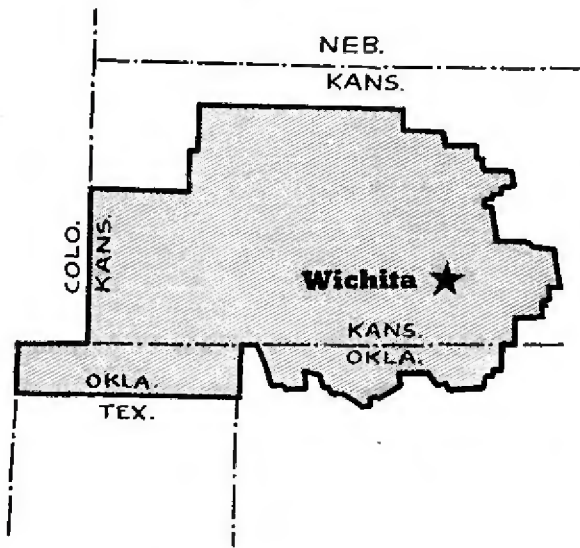

Through The
SUTTON ELECTRIC SUPPLY CO.
WHOLESALE DISTRIBUTORS

Headquarters . . . Wichita, Kans.

Says R. M. Sutton, President:—

"With General Electric's new and revolutionary radio sets I feel an unbounded enthusiasm for the future of those wise dealers who make themselves a part of this new radio future, which will make for them a **BUSINESS OUT OF THE RADIO BUSINESS.**

"We are strategically located to serve throughout our market; equipped completely for serving you quickly and satisfactorily.

"All wide awake dealers will be assured of getting their share of the benefits to be realized, by being the ones in their respective communities to hold the General Electric Radio Franchise."



YOUR CUSTOMERS WILL PREFER
GENERAL  ELECTRIC
RADIO

With the tube that's "Sealed in Steel"

Managing Manpower

(Continued from page 41)

rially reduced. Or, "Have you ever listened to short-waves? Your new set is a dandy but for just \$1 a week extra you could have shortwaves, too." This afterthought remark often adds \$50 to the bill.

And there are still other advantages of the T-O. The store manager determines just what promises have been made by the salesmen, corrects many misunderstandings right at the outset. And in some cases the manager will cut in during a sale, switch from a married man to a youngster of 22. Such a man, for example, can sell a midget to another about his own age much more readily than can a family man farther along in years. Switching, in this case, is good business.

An inflexible rule of the organization is this. Some salesmen must continually face the entrance, ready to welcome any customer who enters. And he does not welcome him with the inane, rising-inflection "Yes?" Or with the equally juvenile "Can I show you something?" Of course he can, and should, show the customer something. That's what the customer ostensibly came in for. The usual greeting, right in line with the training course, is "Good evening, what do you wish to BUY?"

Rotation of the men on the door is important. It prevents starvation of salesmen by more aggressive fellow workers, makes it possible for all to make a living. And it prevents over-energetic employees from rushing the door at the last minute when they envision an under-quota day. Permitted to scramble for late entries, most men, despite company insistence on safe and sane selling, cannot resist promising the earth to get the business. Rotation prevents another common error. Because the force is rotated, each must do his best to sell the customer at hand. For the next one won't be his. Leave floor men on the loose and they will drop lukewarm prospects like hot potatoes, concentrate on almost sure buyers. And the store loses.

Right selling is the heart of the entire plan. "It is not difficult to dominate simply by cutting prices, advertising heavily and pressuring every prospect," says the chain owner. But less than 10 per cent of the business done on this basis is profitable. The remaining 90 is accomplished either at the expense of immediate net or at the expense of the concern's future. We can stand high cost due to returns, complaints and adjustments on 10 per cent of our business. We gladly do, even when consumer demands are excessive. For our reputation for liberality of adjustment is bringing in so much really profitable business that we can afford to take an occasional shellacking from a "crank."

"Liberality with the consumer is our middle name when it comes to adjusting difficulties in reception. We go the limit not because we are philanthropists but because it is good business. But our liberality ceases here. The collection department is run on as rigid a basis as anybody's. So is the credit department. We don't sell poor accounts. And we expect our customers to meet their contract obligations. The same thing applies to service to a somewhat lesser degree. We give 90 days free. And if absolutely necessary to retain a customer's good will we will make one more call without charge. Then we bill him. We find that the consumer has more respect for us when we do and that we do not lose his business."

Only the Finest in the new

ERLA

and

SENTINEL

Three Band Table Model

An extremely sensitive and selective six tube three band superheterodyne, tuning 16.7 to 52, 67 to 200 and 195 to 570 meters. Has illuminated airplane dial, full range tone control and many other important refinements. Guaranteed by the makers to tune in foreign stations under almost any conditions.

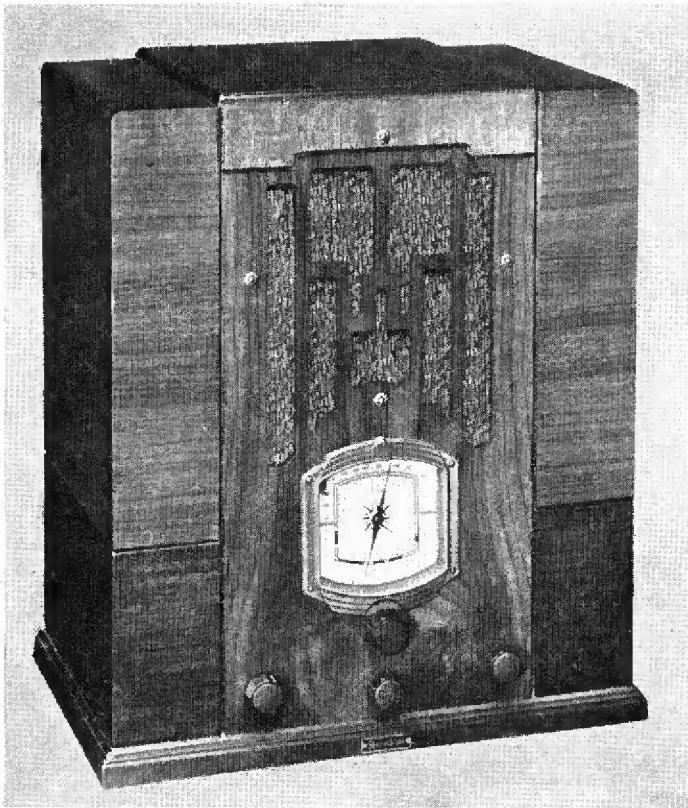

the new **QUAM**

Super-Sensitive

ARMORED DYNAMIC

This new ERLA-SENTINEL needs the most sensitive speaker that money can buy for *world-wide* reception on six tubes. Of course it uses the new *super-sensitive* ARMORED DYNAMIC—the speaker of eternal ruggedness—the 1935 speaker!

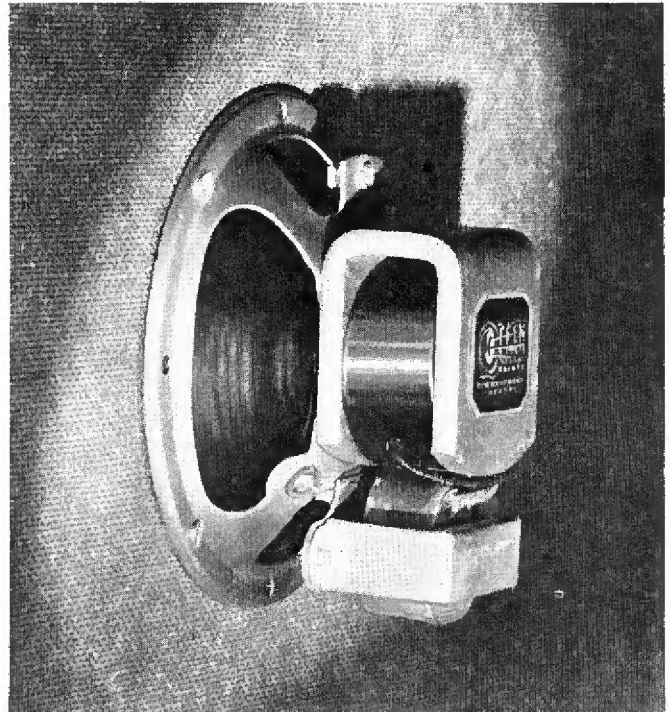

QUAM-NICHOLS CO.

1623 West 74th Street
CHICAGO

"AMERICA'S LARGEST SPEAKER MANUFACTURER"

A Serviceman Cold Canvasses

(Continued from page 18)

relieved to discover you are not a Fuller Brush man.

An amusing experience and one that demonstrates how the name is an "open sesame" was the occasion when I had just started to say, "Good morning, Mrs. Smith—"

I was interrupted by, "Yes, Doctor, come right in. We have been expecting you."

It seems that they had phoned a physician and my knowledge of their name and my "professional manner" deceived them.

One morning an employee of the Public Utility had been distributing gas and electric bills before me. In many instances the bills were placed in the door in such a way that I couldn't help seeing the name and thus check up on the accuracy of my list before I knocked. In every case, where the name differed, I called for the person named on the bill (I do this when a name differing from my listed name appears on the mailbox, rug or letter.) Well, this same morning a door opened in response to my knock and the bill fluttered down. I reached down to politely pick up the bill. "Good morning, Mrs. Smith," I began.

But I was amazed by her quick reply, "Yes, I know the bill is overdue, but I promise to send a check in full, the fifteenth!"

At one home, a sign was prominently displayed, "Mrs. Jones, Dressmaking." Although my list contained a different name, I asked for Mrs. Jones. I was invited in and sold some tubes. When I was ending my visit, Mrs. Jones said: "What I don't understand is—where did you get my name?" She had evidently forgotten her own sign, so I did not remind her, but said I had received her name from a friend.

The people who have done the most for me by recommending me to their friends, and also some of my warmest friends were uncovered by canvassing, but to offset this, let us look at some of the unpleasantness.



Serviceman Kirk at work

After all, I can see the humor in the unpleasant situations, although some did not seem funny at the time.

Of course there is the old familiar canvasser-ridden person who will sing out from the rear of the house: "No, we don't want anything!"

Then there is the belligerent voice so disconcerting to the timid canvasser: "What cher sellin'?!!"

One morning I came to a house where the lady was shouting at the top of her very ample lungs to a neighbor three houses away and carrying on a conversation concerning the latest neighborhood gossip. A sign on the door read: "Agents! Peddlers! Do not knock. Man sleeping in the daytime."

I knocked anyway, because I knew no one could sleep through that yelling. The lady stopped her gossip and howled at me, "Why don't you learn to read English? Can't you see that sign?" That made me hot under the collar, so after expressing my heartfelt sympathy for the poor man trying to sleep through her screeching, I left.

I console myself when suffering from the very few unpleasant experiences, with the thought that I am doing a favor to radio owners (and I *am* by offering certain services free). Many people would be glad to avail themselves of the services I have to offer if they only knew about them. To find those people who want and need me, I must accept the bitter with the sweet.

What They're Plugging

(Continued from page 25)

conservative copy, searched for names upon which its sales staff might call.

PITTSBURGH—Firestone promotes Music as You Ride with the much discussed Firestone Stewart-Warner auto radio, advertising "as low as \$1.45 per week," neglecting to mention the price. *Good Year* retaliates with the "Wings" 6-tuber at \$29.95 cash.

Kappels, the most consistent radio advertiser in town this month spreads a 6-tube foreign and American band "Monarch" midget all over the papers at \$21.75, 25 cents down and 50 cents weekly. Another "Monarch" goes over the counter at \$9.95, still another at 10 cents less. The "General" auto-radio (seen in other parts of the country) goes for \$24.85 less installation.

Horne's balcony promotes the "Wonder" compact, an a.c.-d.c. job, at \$7.95. *Kaufmann's*, influential department store, quotes an anniversary price of \$39.90 on a Grunow console, model unidentified but it is a broadcast and shortwave job.

May-Stern pulled a month-end disposal sale of both appliances and radio, shooting out Majestics, Philcos, Colonials, Crosleys, Kolsters, Kennedys, Westminsters at 19 bucks . . . take 'em away. Models unidentifiable. *Monarch Electric* ran a small ad directed to radio servicemen, advertising specials on brandless replacement parts. *Spear* slugged in small midget space on a \$7.95 American and police-call midget, poking it off in a corner of a large general merchandise ad. Sold an auto-radio attributed to Silver Marshall Mfg. at \$29.95.

Boggs & Buhl pushed a \$12.66 compact from the third floor department. *Frank & Seder* advertised a similar 5-tuber for \$8.95. And the omnipresent *Western Auto* again concentrated on the "Tructone" car set at \$21.95. Later at \$20.95.

NEW YORK—*Davega*, heavy local advertiser, gave the new 1936 Philco line a play, using "15 cents a day" as a catch-line, broke Arkay consoles formerly \$59.95 to \$23.95, sold an allwave Zenith of 1935 vintage for \$39.95, claiming a \$69.95 regular price.

Vim celebrated the opening of a 25th store (Flushing, L. I.) by moving RCA and GE auto sets at \$19.95, Spartons at \$29.50, AK at \$33.95, GE at \$34.50 and Zenith at \$31.50. Sorry we can't identify the models. Tubes said to be nationally known went for 29 cents. Stock of 75,000 claimed but types unknown. And, oh yes, a free electric clock-lamp (and is it a honey aesthetically) went with each set sold.

Good Year advertised the Motorola 57 at \$37.95 cash, less installation. And *Sears-Roebuck* put out a 4-tube car set for \$24.89, a 4-tube compact at \$6.95.

SPARTON'S 35TH ANNIVERSARY ANNOUNCEMENT!

A Sensational

NEW LINE OF RADIOS

WHICH GIVE "PRESENCE" TO BROADCASTING

"Presence" engineering gives dealers a new hot sales advantage. Through the ingenuity of Sparton engineers, "Presence" reproduction has been engineered into Sparton sets. Here are some of the important "Presence" features—*Super-High Fidelity*, which now brings in the complete range of lower and higher notes . . . Sparton's famous *Superheterodyne Circuit* . . . the *Tone Exactifier*, which unscrambles and clarifies reception . . . and the *Triolian Principle*, which uses 3 speakers in several models, giving a full, rounded, "presence" tone. Sparton also provides several models with steel tubes. These sets have been specially engineered to obtain

greatest benefits from the advantages offered by metal tubes.

The whole Sparton line has been so designed that it immediately appeals to everyone with a sense of beauty. While every model is modernly designed, yet it fits into the furnishings of any home. A big merchandising plan backs up dealers with volume and big profit possibilities in Sparton's 35th anniversary year. Our plans are not only big, but they are tried and proved. We are putting every ounce of energy behind this new "Presence" radio line because we feel that it is

the finest line any dealer can sell. We want dealers everywhere to join in with us and profit.

watch **SPARTON** in 1936

• In addition to the high spots mentioned here, every detail of the new Sparton line is the most advanced engineering known today. With such an advanced line and the big sales plan behind it, no Sparton dealer can help but go to town in a big way. Watch for the Official Sparton G-Man. He's after every dealer who wants to make more money this year. We urge you to get all the details about Sparton NOW. The Sparks-Withington Company, Jackson, Michigan. Sparton of Canada, Ltd., London, Ontario.

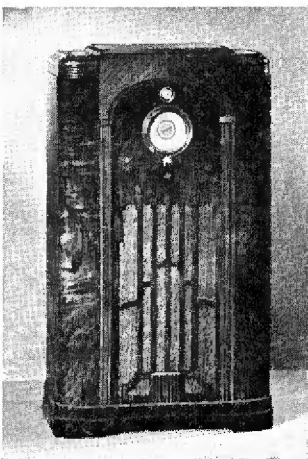

Sparton 766

Smart seven-tube AC console with large 18-inch super-dynamic speaker. Complete all-wave world reception covered by four bands—colored indicator lights. Viso-glo tuning. Fully illuminated airplane-type dial.

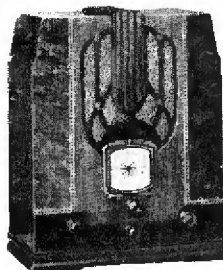

Sparton 616

Modernly designed, 4 band, 6-tube, all-wave table model. Fine tone from adequate baffle area. Illuminated airplane dial. Precision tuning ratios.

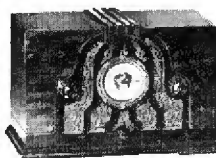

Sparton 506

Five tube, superheterodyne portable, 110-volt AC or DC. Beautiful, unique, modern design. Broadcast and short-wave frequencies covered in two bands. Illuminated, airplane dial centered in grille.

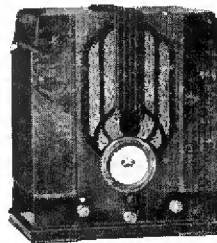

Sparton 716

Seven tube, straight AC superheterodyne table model. Foreign and domestic reception. Attractively priced. Illuminated airplane dial. Precision tuning ratios.

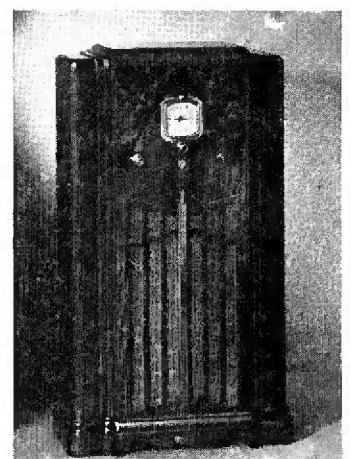

Sparton 666

Truly beautiful, modern 6-tube AC console with all-wave reproduction in 4 bands. Illuminated airplane dial. Precision tuning ratios. 530 k.c. to 20,000 k.c. Sparton's leading console.

"AMERICA'S
OLDEST RADIO
MANUFACTURER"

Presents

THE HOWARD WORLD-SEVEN *with*

***all* METAL TUBES!**

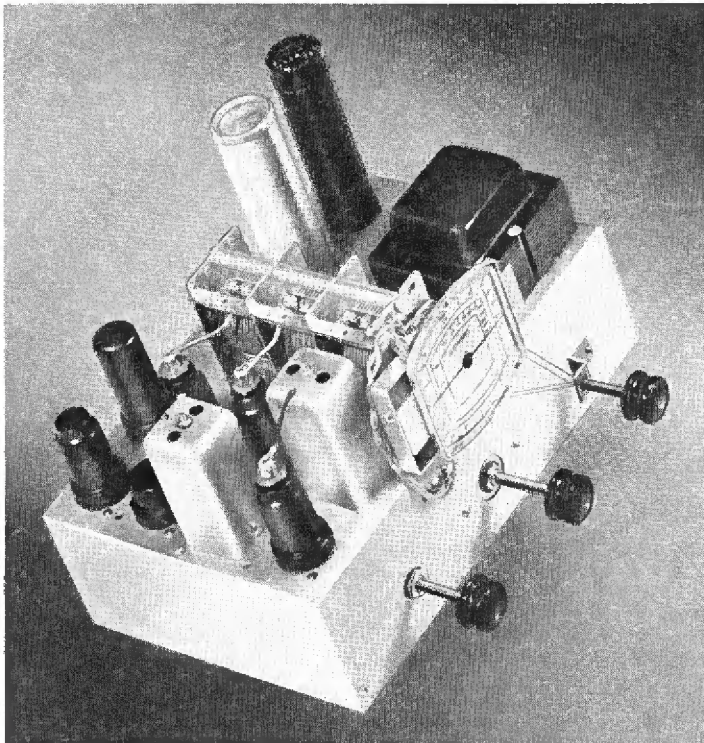

The New Super-Seven has 100% METAL TUBES. It was designed especially to get the utmost out of this great radio improvement. It covers the broadcast band and the *complete* short-wave range. True "round the world" sensitivity, mellow tone, powerful output, automatic volume control, tone control, full shielding, and every modern feature—built of the finest materials obtainable. In a handsome Walnut table cabinet at

\$79.50
RETAIL

Walnut console model at **\$94.50**

**TEN MODELS UNDER
\$100 RETAIL**

Howard's Crystal Anniversary Line includes 11 models: 4 and 5-tube AC-DC compacts, 6-tube all-wave models, 7-tube all-wave models, 9-tube all-wave models, auto-sets, battery sets, and the famous 19-tube Howard Grand.

NATIONAL DISTRIBUTION

You know Howard's policy of building only quality receivers. The 1935 line strictly follows this policy, yet greatly enlarged distribution makes it possible for you to sell Howards this season in price competition with any line on the market! Every modern sales feature is included as well as many Howard patented improvements.

National distribution is rapidly being completed. Tear out a corner of this page and pin it to your letter-head—or wire the factory—for full details.

HOWARD RADIO

BELMONT AVENUE, CHICAGO, ILLINOIS

"AMERICA'S OLDEST RADIO MANUFACTURER,

The Antenna Sells the Set

and when it's a

BROWNIE ALL-WAVE ANTENNA

You make a real
profit besides



We don't have to tell you as a radio dealer that selling a good antenna "sells" the radio set. The antenna is the difference between ordinary reception and mediocre satisfaction with the new set—and the exceptional results that assure an enthusiastic customer who will "stick like a brother."

What we can tell you is that with the Brownie All-Wave Antenna you can now sell a better antenna—and in doing so make a real profit on the antenna itself. That interests you, doesn't it?

The BROWNIE IS MADE to Sell—and Stay Sold

Quality and Outstanding Performance are the positive guarantee back of the BROWNIE. Constructed on the Balanced Doublet System, complete with all quality parts and a new, highly efficient Matching Transformer, we challenge a comparison for volume, clarity and freedom from local noise interference. Easy to install, the BROWNIE saves you time and expense on service. It's the kind of antenna that sets dealers to cheering wherever introduced and has won immediate enthusiasm from customers.

Packaged to Appeal . . . Nationally Advertised

From quality of parts to design—to the package that carries the BROWNIE our one thought has been an antenna that will sell quickly and stay sold a long time. An exceptionally attractive self contained display gains instant attention on your counter. A national advertising campaign to start in the Saturday Evening Post and Colliers will help create a consumer demand.

The only question now is do you want to cash in on this popular antenna that allows you an immediate profit on every sale? We think you do—and that you will write us at once for full details of the BROWNIE and our attractive profit making deal. A postal card will bring it. *WRITE TODAY.* Address: Dept. A, Porcelain Products, Inc., Findlay, Ohio

Back of the BROWNIE is the Experience and Reputation of an Established Manufacturer

The BROWNIE as a product conceived and sponsored by Porcelain Products, Inc., has the background of all the technical and manufacturing experience of this long established concern.

Catering to the electrical industry for years, Porcelain Products, Inc. has built up a staff of electrical and ceramic engineers and laboratory equipment which assures undoubted advantages in the development of any product backed by this firm.

Back of the BROWNIE then, and serving as an additional guarantee to every dealer is all of this knowledge—all of this experience—all of the manufacturing facilities plus the extremely high standards of quality demanded by Porcelain Products, Inc.



PORCELAIN PRODUCTS, INC. . . FINDLAY, OHIO

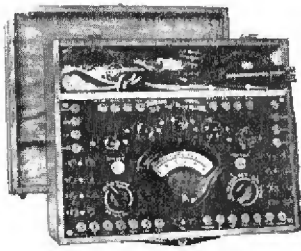

**SUPREME 339—DE LUXE
ANALYZER**

A super-analyzer with direct resistance ranges up to 20 Megs, with self-contained power supply and many other features . . . \$39.95

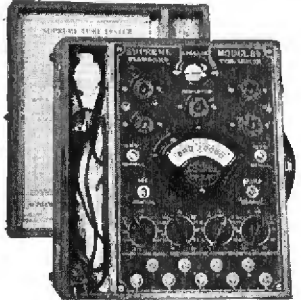

**SUPREME 89—STANDARD
TUBE TESTER**

A new low priced Tube Tester, featuring Supreme's famous Neonized leakage test . . . \$34.95

QUICK FACTS — 89 DeLuxe

1. Simple to operate. (1) select filament voltage, (2) set tube selector per chart, and (3) press a button.
2. Accurate. New circuit tests all tubes at RATED LOAD.
3. Rugged. Cannot be damaged by shorted tubes.
4. Fool-proof. Only 5 sockets—a tube cannot be placed in wrong socket.
5. Neon Leakage tests. Detects leakages and "shorts" between ALL tube elements and indicates faulty elements.
6. Sensitivity of neon leakage test LIMITED so as not to discard good tubes.
7. Quality test detects open circuited elements.
8. All leakage and "short" tests while tubes are heated.
9. Extra handling avoided by making leakage and short tests in same socket used for Quality test on English Reading "Good—Bad" Scale.
10. Tests all tubes without adapters.
11. Fixed ratio between tube and circuit resistance for extreme accuracy on Quality tests.
12. Easily adaptable to future tube developments.
13. Adjustable to varying power supply.
14. First English Reading condenser tester.
15. Accurately classifies all electrolytic condensers as "Good" or "Bad" on meter scale.
16. Neon test of all electrostatic condensers indicating leakages, shorts, or opens.
17. Uses full size neon lamp—easy to see instantaneous leakages.
18. Supreme 5" fan shaped meter, 1000 ohms per volt sensitivity.
19. Volt-Meter for point-to-point testing, 5 D. C. ranges of 0-5, 0-125, 0-500, and 0-1250 volts, 1000 ohms per volt.
20. Ohmmeter. Direct ranges of 0-2,000, 0-20,000 and 0-200,000 ohms, powered with self-contained flash light battery. Low range to 1 ohm with 35 ohms marking at center scale.
21. Megohmmeter. Direct ranges of 0-2 and 0-20 megs, SELF-CONTAINED power pack.
22. Single selector switch converts instrument to (1) English Reading tube tester, (2) neon tube leakage tester, (3) Neon Electrostatic condenser tester, (4) English Reading Electrolytic condenser analyzer, (5) Multi-range voltmeter, (6) multi-range ohmmeter, and (7) a double range megohmmeter.

KEEP YOUR SERVICE MODERN AS RADIO DEVELOPMENT by equipping with **RADICALLY NEW 1936 SUPREME INSTRUMENTS**

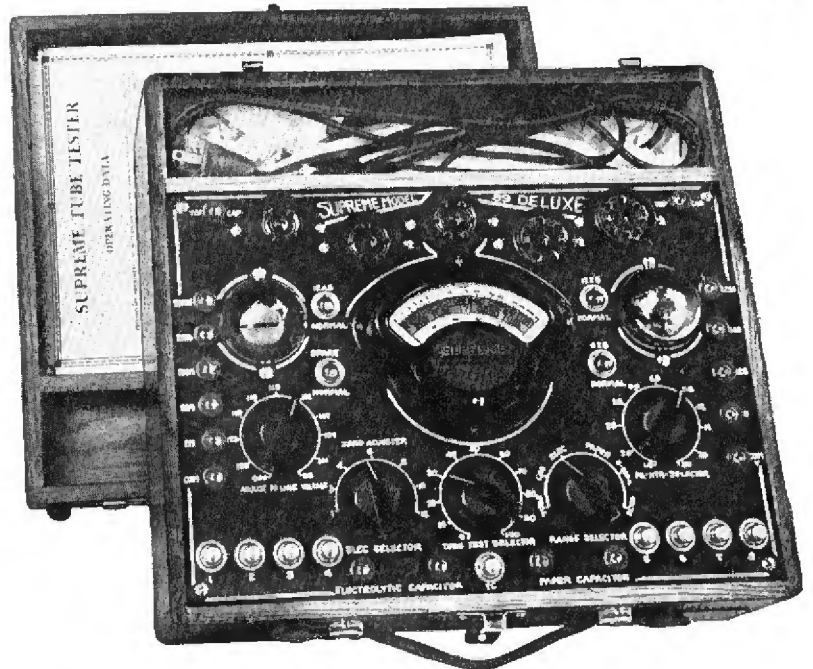
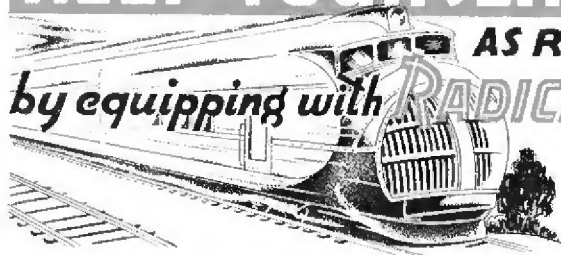

Supreme 89 De Luxe Tube Tester \$45.95

Dealers Net Cash
Wholesale Price

Makeshift methods don't appeal to the radioman who insists on progressive, accurate equipment. He knows he must keep his service as modern as radio developments. An examination of the new 1936 Supreme Instruments convinces him that here is NEW equipment specifically engineered for the new phases of modern servicing—and that accommodations for the new octal tubes is but an incident in the line-up of engineering improvement contained in this always outstanding group. Even more pleasing to him is the new low level of prices for a new high standard of manufacture and testing superiorities.

At \$45.95 the Supreme DeLuxe 89 Tube Tester is radio's greatest offering. Quality built in every detail—7 instruments in 1. 22 of its outstanding features are tabulated at left—but to really appreciate what it means in fast, skilled servicing, get your jobber to give you a demonstration.

URNS INSTRUMENT INSIDE OUT

You can definitely know the "inside story" of the instrument you buy before you buy. Check off here the instrument or instruments you are interested in. Write your name and address on margin below and address to: Supreme Instruments Corp., Greenwood, Miss., and you will receive detailed, complete technical data. Written by engineers who have been servicemen and speak the serviceman's language—know what he needs for profitable production. No cost. No obligation. Supreme 89-DeLuxe Tube Tester. Supreme 89-Standard Tube Tester. Supreme 385-Automatic. Supreme 189-Signal Generator. Supreme 339-DeLuxe Analyzer. Supreme 339-Standard Analyzer. Supreme 391-P.A. Analyzer.

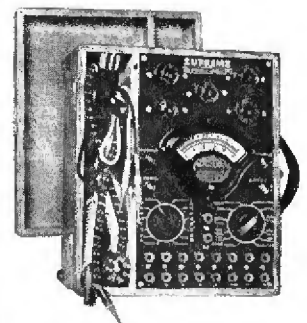

**SUPREME 339—STANDARD
ANALYZER**

A new Free Reference Point Analyzer—the most outstanding value in the low price field . . . \$29.95

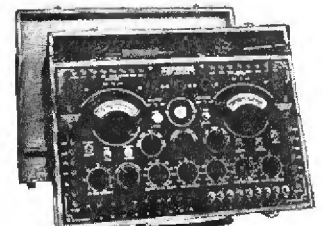

SUPREME 385—AUTOMATIC
A multi-unit instrument, combining features of 339—DeLuxe Analyzer and 89—DeLuxe Tube Tester, plus other flexibility features possible only through Supreme's exclusive uni-construction . . . \$77.95

SERVICE SECTION

CIRCUITS of the MONTH

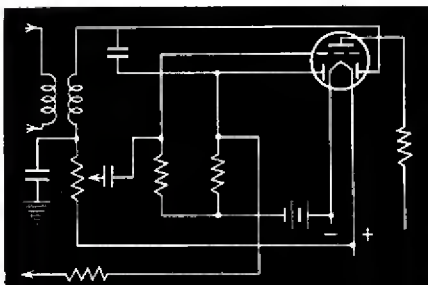

FIG. 1

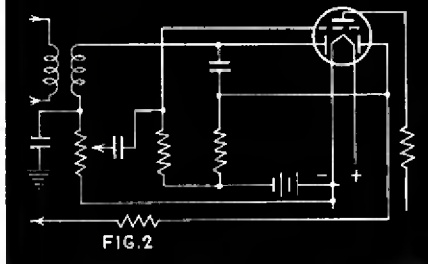

FIG. 2

1B5/25S

The 1B5/25S, a new duo diode-triode for battery use, has the following characteristics: Filament voltage (d.c.) 2. Filament current 0.06 amps. Plate voltage 135 maximum. Grid voltage minus 5. Plate current 0.8 ma. Plate resistance 35,000 ohms. Mutual 575 micromhos. Amplification factor 20. The base is a small 6-pin. Connections, looking at the bottom and reading clockwise are: Filament, filament, triode plate, 2nd diode plate, 1st diode plate and triode grid.

Unlike the earlier 25S this new tube has its diodes below the triode. Each is cylindrical in form and encircles an end of the coated filament. This diode 2 is at the positive end of the filament, while diode 1 is at the negative end. A difference of 2 volts exists between the cathode points within the respective diodes due to the drop along the filament and this drop can be utilized, according to Hygrade-Sylvania, in certain types of a.v.c. circuits.

One diode plate may be used alone for combined detection and a.v.c., using plate 1 and a conventional circuit. A delayed a.v.c. system using both plates is shown in Fig. 1. The diode at the positive end of the filament is used for detection, the one at the negative being

the a.v.c. element. This latter element is biased just by the C battery.

If more delay is required than that of Fig. 1 the diode at the negative end of the filament is employed for detection as shown in Fig. 2, the return being made to A minus. The other diode is used for a.v.c. Since the return for the a.v.c. diode is made to C minus this element, surrounding the positive end of the filament, is biased not only by the C battery but also by the 2 volt filament drop.

Electron-Ray Tuning Indicator

A standard receiving-size "Electron-Ray" tube, designed primarily for use as a resonance indicator in modern sets, has just been announced by RCA, bearing the designation 6E5. (RR scooped again, predicting the tube on page 39 of the June issue!) It is, in effect, a tiny cathode-ray tube of the high-vacuum variety and indicates visually any change in control voltage.

The first cut shows the structural details of the new bottle. The circles at the top of the second cut illustrate the visual effect of bias change, somewhat as it would be seen when looking into the "business end." And the fundamental circuit in which the tube will be used appears at the bottom of this same cut.

Testative data is as follows: Heater voltage 6.3; heater current 0.3; plate supply voltage 250 maximum; target voltage 250 maximum; maximum overall length 3 3/8 inches; maximum diameter 1 1/8 inches. The bulb is the familiar ST-12 and the base a

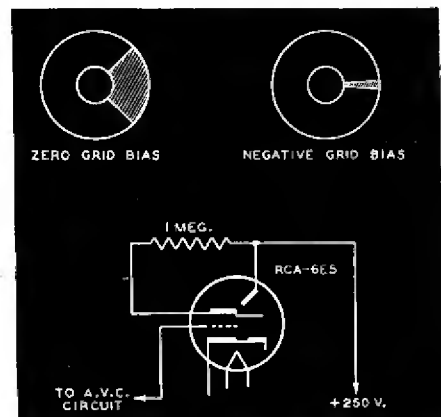
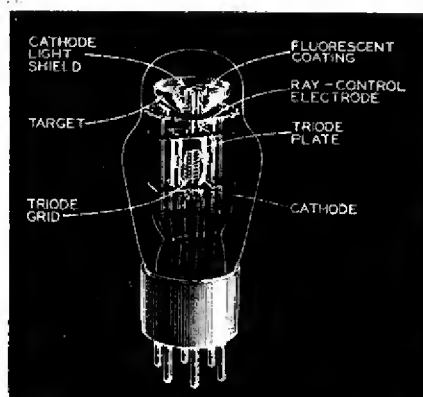

small 6-pin type. Connections, looking at the bottom and reading clockwise from the two large heater pins, are: Heater, heater, plate, grid, target and cathode.

In typical operation at 250 volts plate, both plate and target voltage 250, the series triode-plate resistor will be 1 megohm, target current about 4.5 mils., triode-grid voltage for shadow angle of about 0 deg. 8 volts, triode-grid voltage for shadow angle of about 90 deg. 0 volts.

Self, Grid-Leak and Shunt Bias

A number of the latest chassis diverge from former practice, employ several different types of tube bias. Crosley's model 6V2 is a good example. The r.f. 58 obtains self-bias from a 275 ohm cathode resistor. The input section of the 2A7 oscillator-modulator is similarly biased with a 275 ohm cathode resistor. The oscillator section of this tube is, however, biased by means of a grid-leak and condenser.

The remainder of the tubes are shunt-biased. Voltages are obtained from a divider network connected across the speaker field, which acts as a choke in the negative supply lead. Three resistors, a 500,000 ohm, 100,000 and 25,000 ohm, are connected in series across the field. The i.f. 58 grid-return is hooked between the 100,000 and 25,000. This same tap serves the a.f. amplifier section of the 55 second detector-amplifier but in this case voltage is first fed

Choose

DEPENDABLE SERVICING EQUIPMENT from the complete WESTON line

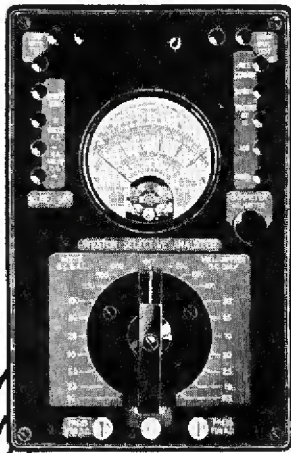

Model 665 Selective Analyzer



Model 301 Rectangular Instruments

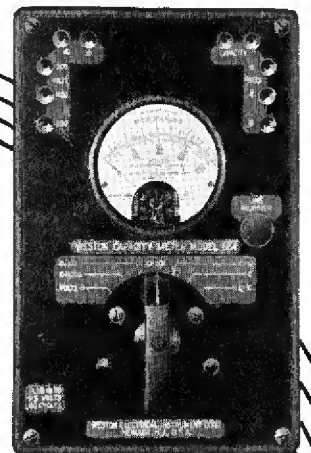

Model 664 Capacity Meter

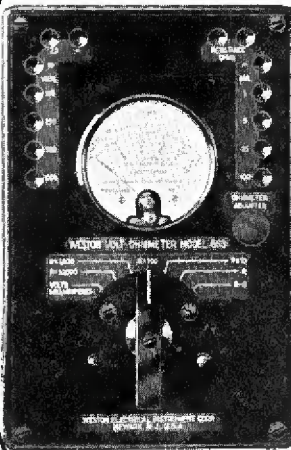

Model 663 Volt-Ohmmeter

Much servicing equipment available looks alike and is intended to perform similar functions. But there the similarity ends. There's a big difference inside the case . . . and that's what counts. For dependability and serviceability must be built into an instrument . . . and are never discernible from outward appearances.

There's one way you can be sure of what's inside . . . be sure that the instrument will serve you dependably and profitably for many years. Just be sure the name the instrument bears is Weston. Choose always by this name for there are Weston instruments available for every servicing need . . . Weston Electrical Instrument Corp., 581 Frelinghuysen Avenue, Newark, N. J.

WESTON Radio Instruments

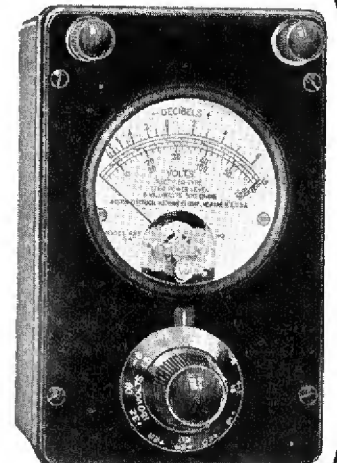

Model 695 DB Meter

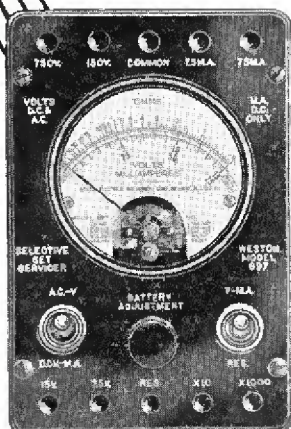

Model 696 Selective Set Servicer



Model 681 Tube Checker

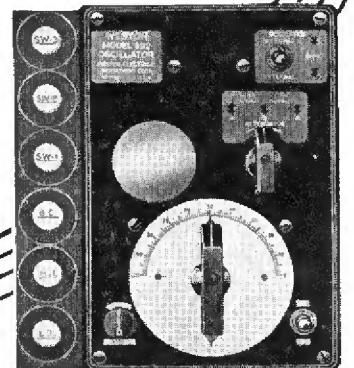

Model 692 Oscillator

through the volume control. The output 2A5 grid return is carried, through a 500,000 ohm leak, to the junction between the 500,000 and 100,000 ohm divider resistors.

Another interesting point in connection with this chassis is its a.v.c. system. Control voltage is applied to the 58 r.f. stage on broadcast, to the 2A7 oscillator-modulator on high-frequency channels.

Pilot Light Switch

In order to minimize A drain, Stewart-Warner's new Model R128D battery receiver is so wired that the 2 volt, .06 amp. pilot is connected across the cell (with the filament dropping resistor in series) only when a push-button switch is depressed.

Not very technical, this item, but we want to pass along all the dope, be it big stuff or little!

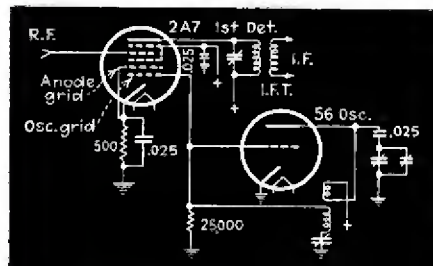

2A7 With Separate Oscillator

Sight of a 2A7 instantly suggests that it is used as a pentagrid-converter, operating as first detector, oscillator and mixer, all in the one bottle. This is not the case in Sperton's Model 134 and 136 thirteen-tube all-wavers. Here the 2A7 is used as first detector and does the mixing job, all according to Hoyle, but a 56 takes over the function of oscillator.

The 2A7 works as a pentode detector and its circuit may be easily checked. But the "anode grid," usually used as the oscillator plate element, is connected to cathode. And the element used as oscillator grid in a straight pentagrid hookup is connected to the output of the 56 oscillator, hence shoots the oscillator frequency into the first detector's electron stream.

Oscillator switching detail is not shown.

A.F. Grid Suppressor

When checking over the Crosley 5V1 chassis used in the DeLuxe Fiver note that there is a suppressor directly in series with the control grid lead to the 42 output pentode. This resistor acts as a filter to remove any residual i.f. from the circuit at this point and also tends to suppress distortion at extremely high volume levels.

MODERN DOUBLE-DOWNLEAD ANTENNAS

Analysis of typical systems . . . Resonant top signal gains . . . Importance of impedance-matching. . . Downlead noise-cancellation and rejection . . . Mechanical and automatic band-switching . . . Practical hints on installation

JUDGING from conversations with servicemen, an aura of mystery still surrounds the operating principles of modern double-downlead antenna systems. And there is small wonder. For so many apparently different types are seen that it is difficult to figure out just what each is supposed to do . . . and how it is supposed to do it.

Fortunately, all systems designed for use with shortwave or allwave sets have the same primary objective, the reduction of pickup by the downleads, differing principally in their method of attaining this end. A secondary objective, and one which introduces further complication, may be an increase in sensitivity to wanted signals over the single-downlead variety of antenna.

Two general methods of making downleads "cold" are in common use: closely spaced low-impedance feeder lines (twisted pair and special two-conductor cables designed for this purpose may have anywhere from 70 to 125 ohms "surge" impedance) which carry a signal introduced at one end to the other quite nicely but are virtually short-circuited insofar as r.f. attempting to impinge upon their length is concerned; and, open lines of higher impedance (two No. 18 wires spaced about 2 inches constitute a line having 550 ohms "surge" impedance) which likewise readily carry a signal from end to end but utilize out-of-phase bucking action between wires to cancel out most downlead noise pickup.

Not all low impedance line systems rely solely upon "short-circuiting" of noise for their action. The cancellation effect frequently helps out to some extent. And, similarly, not all open lines rely solely upon the cancellation effect. Some of them achieve partial impedance matching and a certain amount of noise short-circuiting.

Impedance Matching

Effective antennas present a relatively high impedance to desired signals—that's why they are effective. Receivers not specifically designed for use with special antenna systems have relatively high-impedance antenna input coils (differing quite widely from make to make, frequently from model to model and, in the case of numerous allwave receivers equipped with different input coils for different bands, differing right within a single unit).

When a low-impedance feeder system is used it is necessary to match the low end of the feeder to the receiver's input

coil if good energy transfer is to be obtained. The problem, except for the

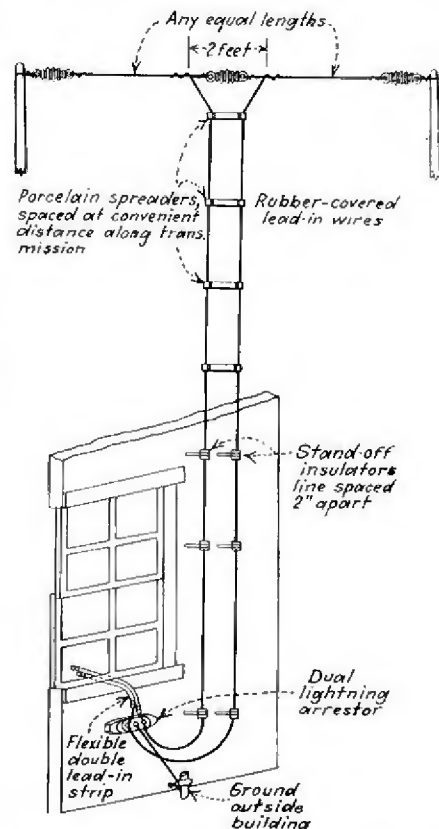

Fig. 1—AK's untuned double-t. Set matching transformer not shown



When it's tough sailing Skipper Serviceman, be nonchalant . . . steer by Centralab. For Centralab Controls are built to "take it" in all kinds of weather . . . under all sorts of adverse conditions. It's smooth sailing under sunny skies if you stock up with CENTRALAB Radiohms for each and every replacement job, which invariably work "better than ever before." Smooth, silent, safe, sure and certain . . . no wonder they are the choice of servicemen who "are in the know."

Write or see your jobber for the new, revised, accurate CENTRALAB VOLUME CONTROL GUIDE.

CENTRALAB
Division of Globe Union Mfg. Co., Milwaukee



Every Radio Service Man should be a member of the Institute of Radio Service Men

Centralab
CRL

**RADIOHMS
SUPPRESSORS
RESISTORS**

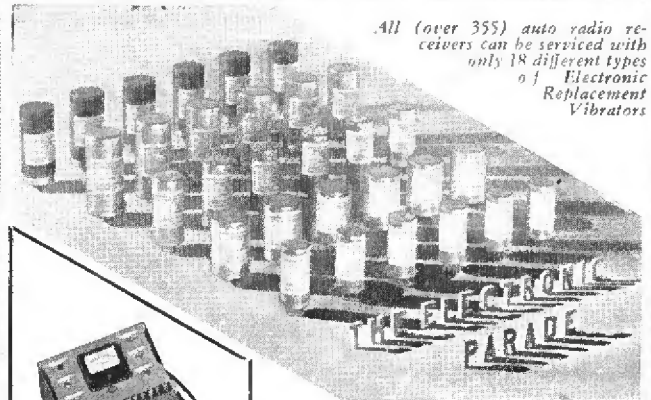

All (over 355) auto radio receivers can be serviced with only 18 different types of Electronic Replacement Vibrators



NEW VIBRATOR TESTER

This Electronic Tester tells instantly in plain English whether a vibrator is good or bad. Also indicates if undue RF interference is produced. Tests every make of vibrator. Operates from 6 volt battery. Counter size. Guaranteed. Send for complete information and prices.

ELECTRONIC Replacement VIBRATORS LEAD THE FIELD

Auto Radio service men everywhere are finding through experience the many advantages of using Electronic Replacement Vibrators exclusively. It requires only 18 types to service ALL (over 355) auto radios. The well known Type 400 alone services over 95 sets and is the most universal vibrator ever manufactured. Electronic vibrators are guaranteed to be of highest quality and they replace as an exact duplicate, or better, in any set. Reasonably priced. Easy to install. Excellent profit margin.

Order Electronic Replacement Vibrators from your jobber today. If he cannot supply you, send us his name. Also write for a copy of our free REPLACEMENT GUIDE—issued monthly.

ELECTRONIC LABORATORIES, INC.

World's Largest Exclusive Manufacturers of Vibrators and Vibrator Power Supplies
122 W. New York St., Indianapolis, Ind.



ELECTRICAL MEASURING and RADIO SERVICING INSTRUMENTS

MANY new developments are now progressing in the Triplet laboratories. Triplet engineers are concentrating on new ways and means to aid the serviceman in obtaining quicker solutions to his testing problems.

The Triplet line includes:

- VOLTMETERS
- MILLIVOLTMETERS
- AMMETERS
- MILLIAMMETERS
- MICROAMMETERS
- POWER LEVEL INDICATORS
- THERMO-COUPLE AMMETERS
- OUTPUT METERS
- AC-DC METERS
- RELAYS

COMPLETE LINE OF TESTING EQUIPMENT

Furnished in All Popular or Special Models and Ranges

SEE YOUR JOBBER'S DISPLAY REGULARLY

Write for catalog.

THE TRIPLET ELECTRICAL INSTRUMENT COMPANY
175 Main Street Bluffton, Ohio, U. S. A.

SERVICE SECTION

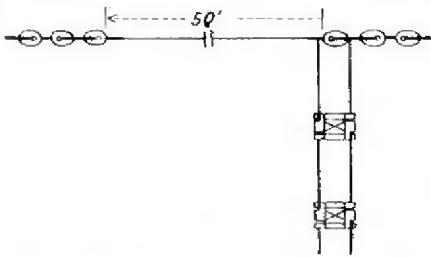

Fig. 2—A "Zep" with transposed feeders. Top half the wavelength of frequency most important to reception, feeders odd multiples of a quarter-wave preferred but dimensions not critical for ordinary "bc" use as antenna works well over broad band

fact that radio frequencies are involved, is much like matching a power tube requiring a 7,000 ohm load to a 20-ohm voice coil. It is, likewise, desirable to match the upper end of the line to the antenna for the same reason, although the sky-end matching is somewhat less demanding, largely because no one knows *exactly* what the impedance of an average antenna really is. That it is high with respect to a low-impedance line we do know. And this necessitates some sort of stepdown. Fortunately, the impedance of an antenna is different at different points along its length. A half-wave wire split at the center, for example, is said to match a 70-ohm line quite closely. So by tapping in on the antenna at the proper points a wide range of impedances may be obtained.

Thus a low-impedance feed system may at first glance appear to have an unmatched top whereas the particular method of tapping in on the antenna in reality constitutes fair matching. The top matching transformer may be an orthodox unit mounted in a protective can or it may simply be a tricky connection of wires. But some sort of matching is necessary between a low-impedance line and the set, and between such a line and the antenna, proper matching at the low end being by far the most important. Without matching, in fact, a low-impedance line, regardless of its wire size, spacing of wires or general construction, refuses to work as one!

Aside from noise reduction there is another reason for achieving the best possible match top and bottom to a low-impedance line. Perfectly matched, and perfection is probably only theoretically possible, very little transmission loss is

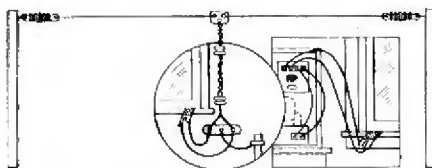

Fig. 3—Consolidated Wire's doublet with twisted pair download. Set transformer not shown. Impedance at center of half-wave doublet matches the line fairly well without special transformer

introduced between antenna and set by a line, regardless of its length. When lines are not perfectly matched transmission losses increase with length.

Matching transformers used at the set end are complicated gadgets. Why this must be so is readily understood when it is realized that, as pointed out above, different sets have different input coil impedances. The antenna designer, unless he makes his system for a specific set, must build a stepup transformer which works well with the *average* receiver. Or must provide it with taps so that a near match is obtainable by swinging a switch.

Open wire line feeder systems relying mainly on cancellation or noise bucking action between wires for quietness similarly require matching at the set end for good results but because the impedance of the line is higher than that of the twisted-pair or two-wire cable systems and more nearly approaches the value of the average receiver's input coil design is not as critical. Transformer action at the top is frequently entirely dispensed with but in studying antenna types keep in mind the fact already referred to . . . that most systems in common use derive some value from both methods of download noise-suppression, the short-circuiting and the

at frequencies lower than the fundamental.

Because receiver sensitivity is generally at minimum down among the shortwaves, and because it is physically possible to erect a half-wave antenna resonating in this portion of the spectrum (loading it slightly if space is at a premium) most allwave systems are designed for maximum effectiveness on shortwaves. They spread out fairly well, although not at maximum efficiency, over most of the shortwave area and in many instances even do as good a job as a common single-download type at broadcast frequencies without special compensation. Frequently, however, they are made so *good* at shortwaves that they attenuate in the broadcast band. And here lies a tale.

In order to avoid attenuation at broadcast frequencies much tricky design has come about. Most engineers are concerned primarily with the building of a system resonant at shortwaves, having a cold feeder giving almost complete freedom from download noise-pickup at high frequencies, and are content with somewhat less efficiency in the broadcast band where receivers are better anyway and where less noise generally exists.

They can't, as a rule, afford to just let the broadcast band "slide" entirely, as it

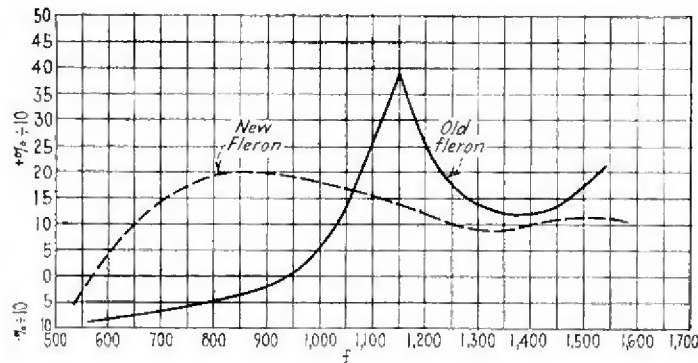

Fig. 4—Curves showing improved "flatness" in response between an early Fleron coupler and a new unit. The original system peaked sharply in efficiency at 1150 kc. The new, utilizing both inductive and capacitive coupling in the transformer at the set end, exhibits only a slight peak at this point and is much better at the low-frequency end of the broadcast band

cancellation effects. Matching, of a sort, is thus frequently discernible even in open wire feeder types.

Resonant Antenna Gains

Now, with respect to the secondary objective of special antenna designers, sensitivity increase over single-download systems. Here's where the subject really branches out and upsets the serviceman's mental digestion. An antenna is most sensitive when cut to approximately half the wavelength it is to receive (actually the length is about 94 per cent of a physical half-wave due to "end effect" . . . which we need not understand . . . "loading" by the antenna-feeder coupling device and proximity to ground). It is less sensitive away from this resonant frequency, even at harmonics, but better at harmonics than

would frequently slide too far by comparison with simpler antenna systems. So many switch in part of the download to work with the top, raising the resonant frequency, accomplishing this mechanically or electrically, sacrificing some download coldness where they can best afford it. The result is generally much improved reception on shortwaves and broadcast band response quite as satisfactory as with ordinary systems completely unsuitable for high-frequency work in most locations.

In the following paragraphs we attempt to describe typical commercial double-download systems, the operating principles of which should now be readily grasped. Before we do, however, we will reverse the usual procedure, state a few general conclusions at the beginning of the article,

SERVICE SECTION

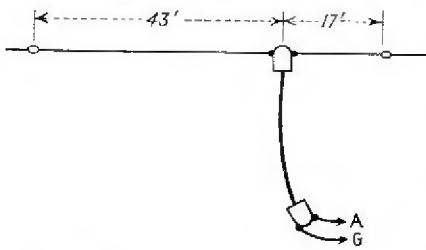

Fig. 5—Philco's new allwave antenna with impedance-matching transformer top and bottom. Employs an unbalanced top, designed to exhibit resonant characteristics at many points, flatten out response

rather than at the end. These, to our mind, represent generally accepted facts and if anyone disagrees these columns are wide open for dispassionate discussion:

1. No antenna system, regardless of what kind of a feeder system and top it uses, will eliminate noise if the antenna proper cannot be installed out of the noise area.

2. If noise is found chiefly in the area through which the downlead must pass modern antenna types will be effective.

3. No feeder system is 100 per cent impervious to radio-frequency pickup. Most commercially-offered types are, however, sufficiently good to be carried within a few feet of moderately bad noise sources without ill effect.

4. Increased pickup due to the use of resonant tops is valuable at shortwaves where signal strength is down, but of less importance than effective downlead noise-rejection in bad receiving areas.

5. Directional effects resulting from certain top placements are rarely sufficient to make weak signals blast the speaker and are more useful as a means of avoiding nearby noise-makers than in increasing distant transmitter signal strength.

6. Out in the "sticks," where noise level is low, both resonant gain and directional effects may be utilized to advantage in squeezing the last iota out of signal voltage. Isolation of the antenna itself from noise is more important in cities.

7. The effectiveness of half-wave antennas fed in the center is reduced if one half must be materially closer to ground, or a grounded object, than the other. Unless the condition is extreme (such as one half the antenna 30 feet above ground, the other 15 over a metal roof) double-downlead systems usually retain an advantage over simple types.

Typical Commercial Systems

Atwater Kent's type D kit (Fig. 1) is an untuned doublet type. An open wire line is used and while a degree of impedance matching is accomplished at the top by tapping the feeders two feet apart on a split half-wave collector most of the downlead noise reduction is accomplished by the cancellation, or bucking, method. As the feeder is of the relatively high impedance type the manufacturer places much stress on the low capacity between leads (capacity bypasses signals in such a high-impedance system) and also in the fact that the feeders may be of any length. This may be explained by the fact that they actually form a part of the antenna

and, except for the cancellation feature, are the antenna.

Certain sets made by this manufacturer, and other manufacturers, have doublet input coils. The kit may be hooked directly to these without the necessity for a matching transformer at the low end. One is available, frankly designed by practical "cut and try" methods, for use with sets not so equipped.

E. F. Johnson makes a similar kit, but recommends the use of transposition blocks instead of the parallel lines, claiming more effective balance of the line, hence more effective cancellation of downlead noise. The kit is available with a matching transformer designed for use between feeder and set and may be used as an untuned doublet, tuned doublet or double doublet. It may also be used "Zep" style, feeders connected to one end of the antenna proper where building layout does not permit the use of the more effective doublet. A Zeppelin type antenna (Fig. 2) is nothing more or less than a folded up antenna. Noise reduction by the downlead is accomplished entirely by the cancellation method. There is a "best" length (half-wave resonant antenna with downlead cut, series or parallel tuned to an odd quarter wavelength) but length is not critical for general "bc" use.

Consolidated Wire recommends a simple doublet kit (Fig. 3) using twisted-pair feeder and an untuned top (a tuned or resonant top may, however, be used). This manufacturer admits that spaced, or transposed leads may perhaps be slightly more efficient, prefers the twisted-pair owing to convenience of installation and freedom from spacer breakage. Inasmuch as the low-impedance pair connects to the center of a split doublet satisfactory impedance matching at the top is secured. A transformer is provided for the low end,

is obtainable with or without a switch permitting substitution of secondaries suitable for matching high and low impedance input coils. Due to design of this transformer signal strength is said to be definitely aided by the system at shortwaves and broadcast performance is not diminished. Short-circuiting effect, more than cancellation, makes the feeders cold.

Belden makes a pre-assembled doublet type (correct antenna lengths fastened to triangular block designed for easy installation in the center of a half-wave doublet) of the tunable variety. It comes with a coupler for the set end, designed to work with a variety of input systems.

Fleron also uses a twisted-pair downlead, plus a doublet top and an impedance matching transformer for the set end. The transformer is interesting in that it employs both inductive and capacitive coupling to provide more uniform response over the desired bandwidth, preserving electrical balance and minimum voltage variation in the twisted leads. Sufficient resonance is obtained in the important shortwave bands (fundamental falling near the middle of this part of the spectrum, harmonics falling in other important sectors) to give some resonant signal gain. A switch mounted on the set end of the downlead permits the system to be converted to an ordinary T-type in the broadcast band (both downleads effectively connected together to form one). A curve supplied by this manufacturer (Fig. 4) shows relative response of the company's new line to set coupler in the broadcast band by comparison with an earlier type. Note that the early system peaked sharply in efficiency at 1150 kc. while the new does not. Both seem most effective at the high end of the band, which is desirable as stations operating there are generally small. Porcelain Products "Brownie" allwave

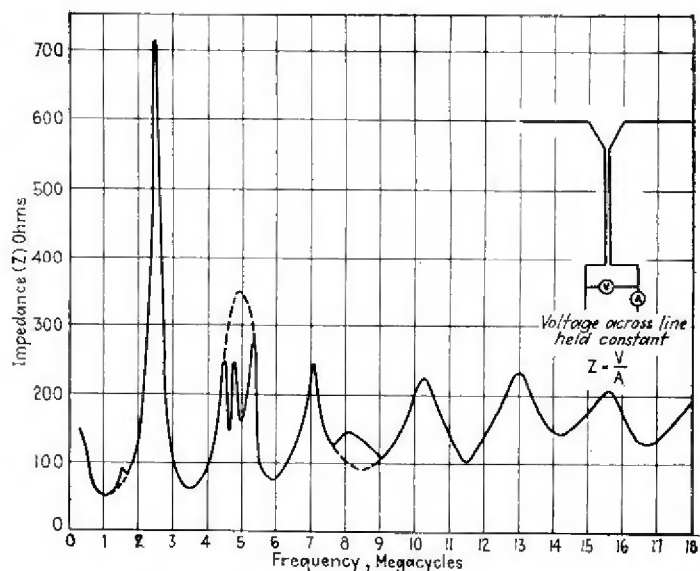

Fig. 6—GE furnishes this set of curves showing the response curve of the V-doublet. Irregular peaks below 9 mc. believed to be due to absorption and reflections from nearby guy-wires, metalwork, etc. True curve in this area indicated by dotted lines

SERVICE SECTION

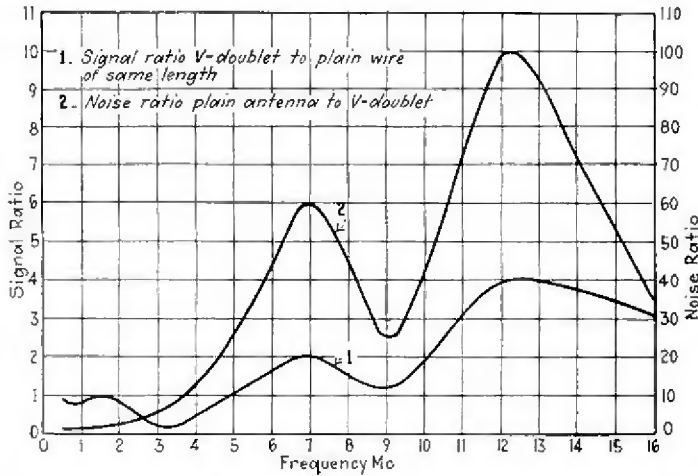

Fig. 7—Another interesting family of curves by GE, number 1 showing the signal ratio of the V-doublet to a plain wire of the same length, number 2 showing the noise ratio of a plain antenna to a V-doublet

antenna is a doublet of the tuned variety, uses a twisted pair low-impedance line connected at the center and assuring a reasonable match at the top. According to the manufacturer the doublet is most effective from 500 kc. to 15 mc. when two 33 ft. lengths are used in the top (resonant at 7,000 kc.). The transmission line comes in 75 ft. lengths and the system is designed to balance best with either a single 75 ft. feeder or exactly double this length. A transformer having a multi-tapped secondary is used at the bottom, permitting matching of line to any average receiver input. Noise reduction in the download is accomplished by short-circuiting effect rather than by cancellation action but, as already explained, some cancellation effect is present in the system, especially when signals considerably distant from 7,000 kc. resonance are received.

Philco's new allwave antenna system uses a stepdown transformer at the top, a stepup transformer at the bottom, converting the twisted-pair download into a low-impedance line. Noise reduction by the download is accomplished almost wholly by its coldness although the twist in this download system (and others using

similar pairs) reduces the area of any magnetic field which may exist about the wires, hence may conceivably utilize the cancellation principle to a limited extent. Perhaps the most interesting thing about the system is its bid for signal gain through the use of resonant top (and possibly part of the download at certain frequencies). The antenna coupler is connected between a 17 ft. and a 43 ft. antenna (Fig. 5) and the resonant characteristics of these two unequal legs, plus resonances built into the top transformer, makes the system peak in several spots located in the shortwave area and also at two in the broadcast band. The result, we understand, is a suitably uniform response curve over the entire range of frequencies received. That it be entirely flat we should not expect. Craftily placed resonant points give peaks where they are most required.

Tobe Deutschmann manufactures a system using low-impedance download and transformers top and bottom. Unlike the device just described it uses either a symmetrical half-wave doublet top or a simpler end-fed flat top, compensation being provided in the couplers to assure satisfactorily flat response across the de-

sired bandwidth, which includes shortwaves.

GE makes a V-doublet (for complete details see page 33 of the May issue) in which a low-impedance transmission line is matched to the doublet top by "fanning" 10 foot long leads from the cable type transmission line to points 5 ft. out from the center of the doublet. Every transmission line has definite surge impedance characteristics, depending largely upon the size of the two wires used and their spacing. If the wires diverge, run away from each other, the surge impedance varies along the length of line, being low where they approach, higher as they diverge. A length of tapered line can be used as an impedance-matching transformer. The widely spaced end has relatively high surge impedance, hence may be connected to relatively high impedance points on the antenna. The closely adjacent ends represent a lower impedance, hence may be connected to a low impedance line.

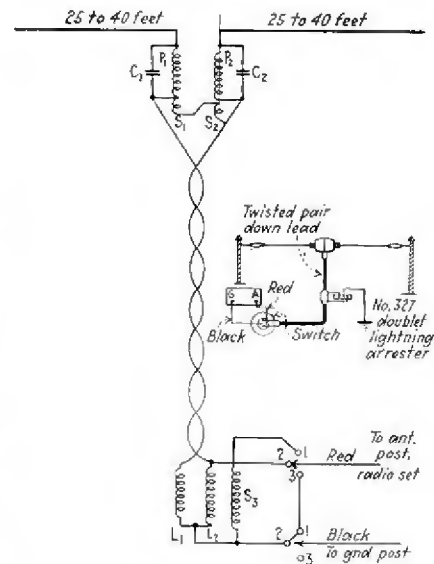

Fig. 9—The Cornish Wire system. It works as a doublet at shortwaves; as a loaded "T" type at broadcast

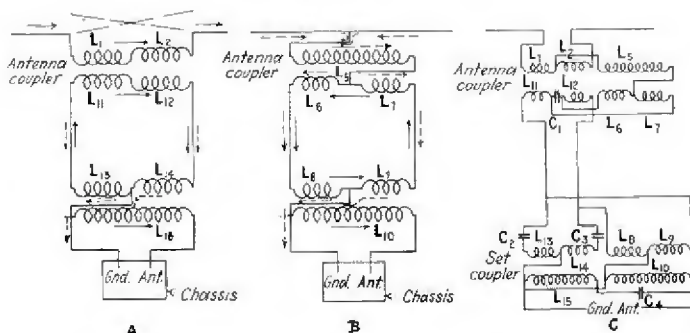

Fig. 8—Schematic analysis of the Technical Appliance system. A shows circuit action at shortwaves, B indicates current flow at broadcast and C combines the two into a complete system. For detailed explanation see text

A matching transformer is, of course, used at the set end. And flatness of response characteristic has evidently been carefully studied (part is due to the "V" top) and built-in as curves provided show a good uniformity of response (Fig. 6) over a broad band and (Fig. 7) considerable resonant signal gain over ordinary single wire download systems.

Technical Appliance makes a somewhat more elaborate system in which both noise reduction and resonant gain actions are different at shortwaves than at broadcast, the system switching from one to the other electrically. Low-impedance transmission line is used and the following explanation of operation is necessarily rather complicated, and will require close reading.

At high frequencies (Fig. 8A) the aerial, acting as a dipole, will induce

THORDARSON CONDENSER TESTER

calls for AEROVOX CONDENSER KIT

When you build that condenser capacity and leakage tester—and you may need it in your servicing—don't overlook the condensers specified—AEROVOX. To simplify matters, AEROVOX offers the Thordarson Condenser Tester Kit—seven units, \$3.39 dealer's cost, saving you money, time, disappointment.

FREE DATA

Thordarson condenser tester data on request. Also Aerovox 1935 catalog and sample copy of Research Worker.



74 Washington St. :: :: Brooklyn, N. Y.

RADOLEK AMPLIFIERS bring AMPLIFIED PROFITS!

8 WATT
A.C. Operated

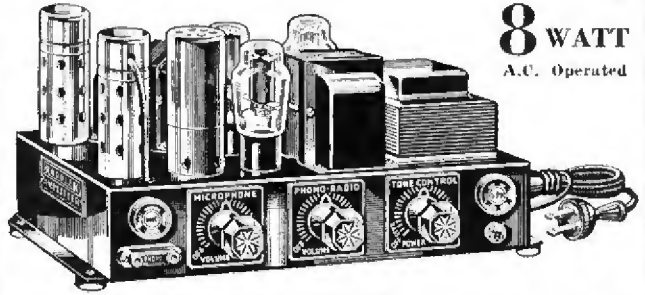

—the **HIGHEST GAIN AMPLIFIER** ever made in one unit

RADOLEK'S line of Quality Public Address Equipment covers every P.A. Need. A complete range of Amplifiers from 4 Watts to 80 Watts. Permanent sound systems, Mobile units, Portable systems, Battery operated and AC operated—each one precisely engineered and laboratory built, leaders in their respective class. This complete line is available to you at **LOWEST WHOLESALE PRICES**. Send for RADOLEK'S New P.A. Book—the greatest Catalog of Sound Equipment ever published. Arranged to show List Prices only. Start making money immediately. Send for your copy of this Book—today.

Above is shown the new RADOLEK AC operated, Superior-Quality, Four Stage, High Gain 8 Watt, All-Purpose Amplifier, designed to give **MORE POWER** and **BETTER PERFORMANCE** at **LESS COST**. Has all the New **FEATURES**: Individual Input Volume Controls, Plug-in Input and Output, Complete Mixer and Padder, Tone Control, Provision for either AC or DC Speakers and **TWO** Input Channels. All built in. No detached controls. Can be used with a Crystal Microphone or Carbon, Dynamic or Velocity Microphone. List Price, \$57.50 Complete with tubes. Standard Dealer discount.

Send for the NEW RADOLEK PROFIT GUIDE!

It's now ready. Not just a catalog, but a Complete, New Radio Encyclopedia—Thousands of items accurately illustrated and clearly described. New charts, diagrams, valuable technical data. This Profit Guide is truly a "Guide" to Bigger Profits—Distribution is limited to active and legitimate Radio-Men. Send your business card or letterhead to be assured of getting your copy immediately.

620 W. Randolph Street
THE RADOLEK COMPANY
 Chicago Illinois

"JUST THE INFO I NEEDED TO DO A QUICKER, BETTER JOB OF SERVICING"

THE CATHODE RAY TUBE AT WORK

JOHN F. RIDER PUBLISHER.

\$2.50
320 PAGES

• It would be pretty foolish to attempt any type of radio work without a soldering iron, wouldn't it? The average Serviceman feels the same way about Rider. Now Rider brings out a new book to help the Serviceman do profitable servicing. "The Cathode Ray Tube at Work" contains 320 pages of illustrations and descriptive text in easily understandable language on theory and practical applications of the Cathode Ray Tube to modern servicing. Experiments in actual servicing on amplifiers, P.A. equipment and "ham" x-mitters were performed in our own laboratory.

For the "Dope" on Sets from 1919-1935 Rider's Trouble Shooters Manual Vols. 1, 2, 3, 4, 5.

- Vol. 5—1204 pages; separate complete 64-page index\$7.50
- Vol. 4—1060 pages; separate complete 40-page index\$7.50
- Vol. 3—1070 pages \$7.50
- Vol. 2—800 pages \$6.50
- Vol. 1—1000 pages \$7.50

RIDER'S MANUALS HAVE more schematics . . . more I-F peaks . . . more alignment data . . . more circuit descriptions . . . MORE EVERYTHING than any other manuals! Yes! No duplication in any Rider Volume!

Service Superhets—A comprehensive, easily understood explanation of the Superheterodyne, 288 pages\$1.00

PATRONIZE YOUR DEALER

FREE . . . Are you keeping your Manuals up-to-date? "Successful Servicing," our 12-page monthly house organ keeps you informed of all changes and additions to the manuals, free of charge! Send in coupon—NOW!

John F. Rider, 1440 Broadway, N. Y. C.

Dear Rider: Send me "Successful Servicing" right away.

Name

Address

RIDER Publications JOHN F. RIDER PUBLISHER

RR65 1440 BROADWAY • NEW YORK

"RED HEAD" AUTO ANTENNA

GREATER DISTANCE ON ALL SETS

Absolutely weather-proof—No flat surface to accumulate mud and water which will deaden efficiency

FOR ALL MAKES OF CARS

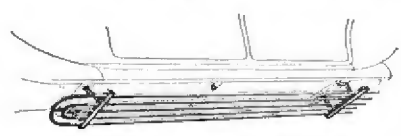

SIMPLE INSTALLATION NO HOLES BORING NECESSARY
RETAIL PRICE \$2.75

JOBBERS—Write for our profitable deal.
SERVICEMEN—Write for circular "Tips on Auto Radio Installation."
VICTORY MANUFACTURING & DISTRIBUTING CO.
 3104 MICHIGAN AVE., CHICAGO

110 VOLTS AC ANYWHERE

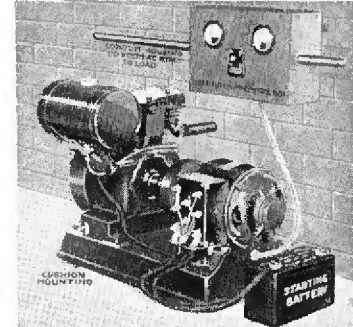

All Models self cranking. Runs standard AC appliances such as AC radios, pumps, refrigerators, sound truck amplifiers, etc.

Sizes 300 to 5000 watts. Burn gasoline or kerosine. Two Diesel sizes 3000 and 7000 watts.

Write your jobber or to us for interesting descriptive literature.

KATO ENGINEERING COMPANY, Mankato, Minn., U. S. A.
 Mfg. of Converters, A.C. Generators, Windmill Light Plants and Chargers

SERVICE SECTION

currents traveling at opposite directions (solid arrows) in the transmission line. Any interference currents induced in the transmission line will travel in the same direction (indicated by dotted arrows) and these currents will pass through the center tap of the lower coupler to ground. Only voltage introduced at the antenna proper creates an EMF in the secondary of the antenna coupler, applied across the transmission line and carried to the primary of the set coupler, the secondary of which delivers an EMF across A-G.

At broadcast frequencies (Fig. 8B) the action of the currents will be somewhat different. The primary currents, indicated by dotted arrows, pass through the high inductance primary winding L5 into the center-tapped secondaries L6, L7 and through the transmission line to the set transformers L8 and L9, thence down to ground through the midpoint. These primary currents generate no voltage in the secondary L10 by virtue of the fact that they enter in opposite sides of the windings and leave by the center tap. The secondary currents (indicated by solid arrows) induced in the antenna L5, L6 and L7 are of the same nature as those produced at high frequencies by the dipole action, as previously shown, circulating up and down the transmission line. Any EMF interference induced in the line is balanced out in the same manner as in the case of the high-frequency transformers.

To make an automatic allwave system out of these two sets of transformers they are superimposed (Fig. 8C). In this combined circuit the high frequencies are blocked from the low frequency transformer by virtue of the high inductance winding L5, but transformers L1, L2, L11 and L12 will pass them into the transmission line. Condenser C1 completes the circuit L11 and L12 across the transmission line for high frequencies but blocks the low frequencies. In the lower transformer the high frequency currents pass through C2 and C3 into the high frequency primary windings L13 and L14. The passage through L8 and L9 is blocked by the high inductance of these windings. The standard broadcast signals coming down the transmission line to the lower transformers L8 and L9 are blocked from entering L13 and L14 by the condensers C2 and C3. The condenser C4 blocks the standard broadcast signals from passing through the low impedance secondary L15 to ground. The values of L10 and L15 are chosen to match the input impedance of the standard allwave receivers on the market at this time, having more or less high impedance input for standard broadcast band and low impedance input for high frequency bands.

Whew!

Arthur Lynch produces an elaborate system similar to the one just described and, in addition, several simpler types much like some of those described in earlier paragraphs.

Cornish Wire (Fig. 9) likewise has a system, using top and bottom couplers, low-impedance transmission line and provision for switching in impedance-matching windings between the low end

of the line and the set. Action of the system is described as follows:

Fundamentally, it consists of a doublet antenna, in the center of which is placed double transformer P_1P_2 with reversed secondaries S_1S_2 . The twisted pair downlead is connected across the secondaries S_1S_2 and also to the halves of the dipole through bypass condensers C_1 and C_2 . Therefore, for shortwave reception the double transformer is bypassed and the system operates as a standard doublet with circulating currents produced in the downlead wires by virtue of the phase difference in the currents generated by the action of the shortwave signals on the dipole antenna.

Interference in the downlead wires is eliminated by making all noise currents which enter the downleads by capacitive coupling to nearby electrical equipment oppose each other in the "bifilar" primary winding of the set coupling unit due to their generation of equal and opposite voltages.

For broadcast frequencies the double transformer comes into action in the following manner: The primary currents direct from the two halves of the doublet antenna neutralize each other, since at broadcast frequencies the antenna no longer acts as a doublet, but the currents from the reversed secondaries S_1S_2 are additive and therefore produce circulating currents in the downlead wires and also in the primary coils L_1L_2 which are coupled to the stepup secondary S_3 to

match the impedance of the average broadcast receiver's input coil, said by this manufacturer to be from 3,000 to 5,000 ohms.

In Review

Now that we have been through the mystic maze we find it advisable to review once more, the objectives of double-downlead antenna designers. These are:

First, and most important, the reduction of downlead noise pickup. This is accomplished (a) by using low-impedance feeders (properly matched to antenna and set) to produce a cold line which is practically short-circuited with respect to r.f.; (b) by using higher-impedance lines cancelling or bucking out noise picked up inductively in either wire, and (c) combinations of both methods, such combinations being deliberately introduced or accidentally achieved.

Second, and of less importance, the increase of signal strength in the shortwave spectrum through the use of resonant antennas. When this is an objective the designer strives (a) to achieve it without any or too great a sacrifice of pickup and transmission efficiency at broadcast frequencies, and (b) without sacrificing noise-reducing effectiveness, particularly in the shortwave bands. For noise-reduction is obviously the primary purpose of special antennas and all else must, if necessary, be subjugated.

Keep these two facts in mind and the subject is not as complicated as it seems.

SHOP SHORTCUTS

Practical Hints On Aerial Installation

By Nick Hogenbirk and
J. P. Kennedy

Belden Manufacturing Company

A good ground connection is the cheapest insurance against noise. Used with an

L or T type antenna it is especially important. Fig. 1 suggests a good method of attaching a flexible, rubber-covered wire to a water-pipe with a C clamp. The wire is bared and firmly bound to the pipe and the clamp used only to make a more perfect electrical connection. Where possible, attach the ground to the section of cold water pipe between water meter and main.

Avoid, if possible, joints in an aerial or ground system. If the wire must be spliced

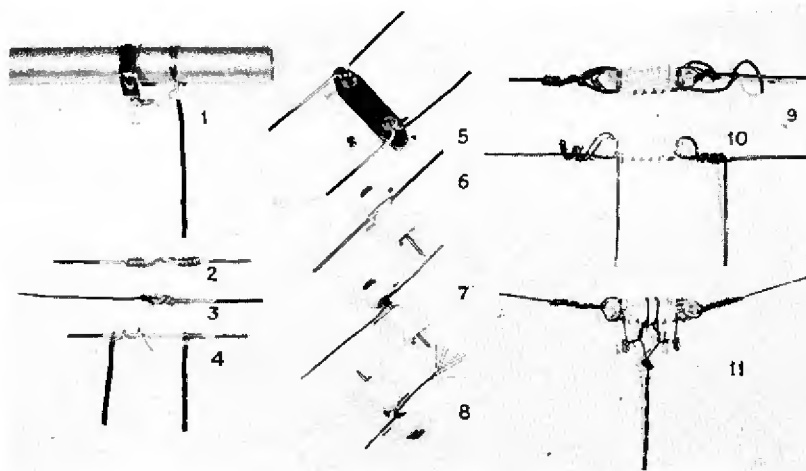



MUTER *Certified*
RESISTANCE BRIDGE

It will not lose its calibration. Its resistors will not change value. Its accuracy far exceeds even the best "ohmmeter." Its price makes this laboratory instrument practical for service work. Ask your jobber or write Dept. A-7 for details.

\$29⁷⁰
DEALERS NET

The **MUTER** Co.
1255 South Michigan Avenue, Chicago, Illinois



UNIVERSAL STUDIO FLOOR STAND

A mechanically perfect, ruggedly built floor stand—Smooth in operation—Positive clamp lock—Equipped with blank call letter name plate—Finished in highly polished chrome plate—Base in frosted silver crackle—Each stand equipped with cadmium plated, adjustable and detachable copy holder as shown, at no extra charge—A clean cut, businesslike stand at an especially attractive price.

Complete, with 8 springs—List \$15.00

UNIVERSAL MICROPHONE CO., Ltd.
424 Warren Lane, Inglewood, Calif., U. S. A.

little giant

Ultra-compact

ELECTROLYTIC CAPACITOR

Half former sizes—full capacity—full voltage protection! Minimum thickness means they fit anywhere. Use this latest advance in the electrolytic art! *Send for literature.*

All Usual Capacities in 2 ratings—150 v.w. and 200 v.w.

SOLAR MFG. CORP.

599-601 Broadway
New York City

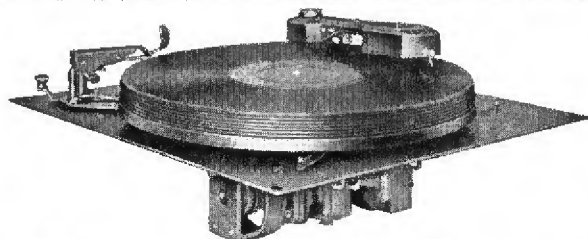

To Phonograph Manufacturers Who Have NOT YET TESTED These New Automatic Units:

ORDER samples of the new General Industries Record Changers. Test them out in your own cabinets or portables. Find out how simply, efficiently they are constructed. How quickly they are installed. How little space they occupy. How remarkably they perform—smooth, silent, dependable, with exceptional clarity and fidelity of tone. THEN—consider the price. Figure out what an unprecedented low price you can ask for your finished product—with this temptingly attractive modern feature of automatic playing, so popular right now with the record-buying public.

General Industries Automatic Units come complete, self-enclosed. Two-speed adjustable motor—turntable—tone-arm and pickup—record changer—all four compactly assembled, ready to install. Two models. "E" plays and changes eight 10-inch or seven 12-inch records, repeating last record. Model "K", especially for 10-inch, changing by hand. All commercial voltages and frequencies, AC, DC and AC-DC universal. We invite your order for samples to test. Write us today, specifying required voltage and frequency for your current.

The GENERAL INDUSTRIES CO.

3537 Taylor St., Elyria, Ohio

Makers of famous precision-built FLYER Phonograph Motors

Contains Complete Service Section Each Month

During the first six months of 1935 *Radio Retailing* has run one hundred pages of editorial material and advertising pages directly addressed to service men.

Each month the editorial pages contain specific, "how to" material of the most valuable kind. Each month the advertising pages contain advertising messages from leading manufacturers of service equipment and replacement parts.

Your story in the service section of *Radio Retailing* will help you get your share of the business. August forms close July 27th.

RADIO RETAILING

330 West 42nd St., New York, N. Y.

SERVICE SECTION

make connections as shown in Fig. 2. Scrape or sandpaper the wire, then cross the two strands and bind in opposite directions. Solder the finished joint, coat with lacquer or electrician's tape.

Joining a soft, flexible wire to a stiff wire may be accomplished by first making a mechanical junction and then the electrical bond. In Fig. 3 a length of solid wire has been cleaned and a loop formed, the flexible wire, insulation and all, has been knotted into the loop. A bare portion of the flexible wire is then bound to the solid back of the loop and soldered.

Fig. 4 illustrates another method of joining a flexible wire to a solid wire. The flexible wire encircles the solid once, is bound back on itself before being wrapped a number of times around the solid wire again.

A lightning arrester should be part of every outside antenna installation. Keep it outside the building, protected from rain if possible. A washer is provided on the binding posts of most arresters and should always be placed between the nut and the wire.

Important in reducing losses is the elimination of inductive loops in the leadin. Fig. 6 illustrates a method of taping a wire at the point where a nail-it knob holds it in place. In Fig. 7 the wire is shown looped about the nail, forming a beautiful iron-cored choke! This is not desirable for shortwave work although its effect might not be noticeable in the broadcast band.

Fig. 8 illustrates the danger of looping stranded wire around the nail of a knob. Some of the strands are likely to be cut and will cause noise as well as transmission loss. Attaching the far end of the aerial to a strain insulator is purely a mechanical problem. Two loops through the insulator eye is best, as in Fig. 9.

Two popular methods of making the leadin bend of an L type antenna are illustrated in Fig. 10. The one on the left is preferable for shortwaves as the loop doubled back on itself is non-inductive. Also, the wire does not have to be threaded through the insulator eye, which is a convenience.

Fig. 11 suggests a convenient method of using an ordinary strain insulator as the center of a doublet. Two of the grooves in the insulator serve to anchor the leadin wires. The object is to permit the utmost flexibility without straining the electrical connection. Center insulators designed expressly for this purpose are better, of course, and several companies make antenna kits including them.

Voice-Coil Rub

By George Danvers

In many of the new type auto-radio speaker assemblies a wire mesh or screen is used to protect the cone. To check for voice-coil rub when servicing such speakers place the thumb gently on one corner of the diaphragm and push it down about $\frac{1}{8}$ in. The coil should not rub. Do this in four corners. If the coil rubs adjust the speaker.

TRICKS of the TRADE

1933 BUICK. Brake static . . . Cotter pin in front wheels is usually loose. Place a lock washer under each pin to hold them tight.

1933 CHEVROLET. To completely eliminate generator interference . . . Connect condenser to second field wire of the generator. Stop-light noise . . . Bridge switch with a 1 mfd. condenser, connecting from terminal to terminal instead of from terminal to ground, the usual method.

CHRYSLER. Static discharge due to drag emergency brake on driveshaft, occurring whenever motor is not actually driving the car . . . Mount holder for small carbon brush so that it makes contact with the emergency brake drums, insert a brush and ground the holder.

EDISON R1, R2, C1, C2. Three major weaknesses . . . 12,500 ohm series plate, 1500 ohm c.t. 50 bias and 25,000 ohm loss resistor. The first two have asbestos washers at the ends. These absorb moisture and transmit dampness to resistors, shortening life. Replace with bakelite washers. The third resistor should be replaced with a 10 watt job whether it tests ok or not.

GLORITONE 99 (APEX). Distorts at high volume level . . . Usually due to open 4 mike electrolytic. Also check 400,000 ohm resistor from 47 grid to voltage divider for change in value or open circuit causing high pentode plate current. If 47 is weak, other tubes ok, this may be the cause.

MAJESTIC 60, 70, 80. To increase sensitivity and volume . . . Place a 250 mmf. mica condenser between the contact arm of the 10,000 ohm volume control and the low end of the variable r.f. coil in the first r.f. stage. Noise will also be reduced by this addition.

PHILCO, AK, MAJESTIC 500 MIDGETS. To eliminate slipping of the tuning gang assembly . . . Remove the flange that holds and bears on the three ball-bearings that gear the rotor. Place on bench, then place washer from a snap-switch over same and tap evenly with a socket wrench of the correct size. Assemble and gang will not slip.

PLYMOUTH 6. Persistent generator noise, despite installation of cutout condenser . . . Eliminated by making sure that the condenser is fastened under the cutout screw next to the engine, rather than under the one next to the hood.

RADIOLA 67. No control of volume . . . Nearly always traceable to open 310 ohm end section of voltage divider, located in tuning chassis. Difficult to check because placing of an ohmmeter across this section will not show it up as one side is grounded and the other is only about 4,000 ohms above ground. Use a 25 watt replacement.

RCA 121. Motorboating . . . Open 4 mike section of capacitor pack (I.F. 175 kc.).

RCA 30, 30A. Burned out 876 ballast tube . . . When customers refuse to spend money to replace it wire two lamp sockets in parallel in its place. Place a 75 watt electric bulb in one and a 100 watt size in the other.

SILVERTONE 1506. No reception . . . Look first for a shorted .01 mfd. bypass between the 47 plate and grid. This is a common ailment.

SILVERTONE 1640. Undesirable time lag in a.v.c. system, weak stations interrupted during static bursts . . . Replace the .1 mike fixed condenser in the a.v.c. circuit with .01. Hiss or feedback in 283 tube . . . Insert r.f. choke in red plate lead of tube. If one does not cure trouble put another in the other plate lead. This noise may affect nearby sets as well as the receiver itself.

SILVERTONE 1570, 1574. Electrolysis in output transformer . . . Commonly encountered due to use of paper winding form which evidently contained some chemical heightening this effect. Use a bakelite form when repairing or place Empire cloth between winding and paper form. Pre-heating and sealing in some moisture-proof compound also recommended.

SIMPLEX PA. Dial slips in this dual band Aircell battery type . . . Quickest permanent cure is to slip a $\frac{1}{8}$ by $\frac{1}{8}$ rubber grommet over the shaft and wind cord around this grommet instead of the bare shaft, as originally equipped.

STROMBERG 635, 636. "Mushy" or choked reception . . . See if pilot light socket shorts to chassis.

TRUETONE O52 SERIES (Wells-Gardner). Weak reception . . . Check .1 mike condenser from 35 screen to ground. Replace 250,000 ohm, eighth watt resistor from 2nd detector 57 plate to 80 filament even if it tests ok. On load it sometimes drops plate volts from 180 to 100. Use a one-watt carbon replacement. (I.F. 262 kc.)

THOUSANDS OF DEALERS AND SERVICEMEN ARE POCKETING THESE \$\$\$

- Actual experiences of thousands of dealers and servicemen since Arcturus introduced its new Dealer Profit-Plan conclusively prove that Arcturus' sound sales policies advance retailers' interests.

- Throughout the country, Arcturus dealers daily are making a bigger profit on every tube they sell. And they're selling more tubes than ever before—for set owners recognize Arcturus as a reputable product that has not been sacrificed to price.

- Dealers *know* they can honestly and safely recommend Arcturus for *real* performance; that Arcturus is accepted by millions of users in this and 78 foreign countries as the quality tube.

- If you are not already participating in the Arcturus plan that increases retailers' profits, ask your Arcturus Distributor, or us, for full details. Arcturus Radio Tube Company, Newark, New Jersey.

ARCTURUS RADIO TUBES



- *Two Year Guarantee*
- *Low Power Factor*
- *Long Life*
- *Self Healing*
- *Efficient & Compact*
- *Patented & Patents Pending.*

Millions in Use

THE superior quality and performance of millions of Duco Condensers are recognized all over the world.

NOW GUARANTEED
FOR 2 YEARS

Manufactured by
DUMONT ELECTRIC CO., Inc.
453-5 Broome St., New York, N. Y.

Write for free Catalogs, Sales and
Jobber Territory

CARRY EXTRA PROFITS INSIDE THESE TWO CASES!

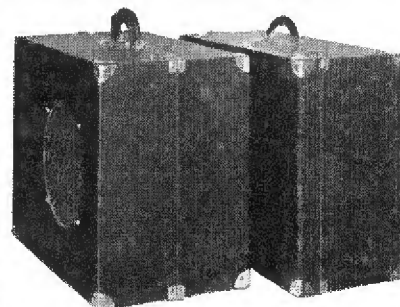

USE

Write for special circular on the new U-39 Public Address System that comes complete in these two cases. Amplifies voice and music for crowds as high as 10,000. Uses ribbon microphone. Simple as a radio. Profits on both rentals and sales!

Do you want literature on U.S.E. Cathode Ray Test Equipment? Write.

UNITED SOUND ENGINEERING CO.
Manufacturers of Specialized Sound Equipment
2237 UNIVERSITY AVE. ST. PAUL, MINN.

For Every Dealer and Serviceman in the Radio Business

- RADIO RETAILING is the publication of the home entertainment merchandising field. It is edited for three classes of readers: first, retailers of radio equipment, including primary radio dealers, electrical dealers selling radio equipment, music merchants selling radio equipment, department stores with radio departments, furniture stores selling radio, auto supply stores selling radio, and other types of radio retailers; second, distributors or jobbers of radio sets, tubes, accessories, and parts; third, service managers and service men, both those in business for themselves, and those working for radio dealers who must install and service radio equipment. The magazine is designed to help its readers sell and service more radio sets, accessories, and parts.



Published Monthly SUBSCRIPTION RATES

Payment must accompany each order at these reduced prices:

United States	\$1.00 a year
Canada	1.50 a year
Mexico, Central and South America....	2.00 a year
All other countries..	3.00 a year
Single copy price	25c.

McGraw-Hill Publishing Company, Inc.
330 West 42nd Street New York, N. Y.

SEARCHLIGHT SECTION

EMPLOYMENT and BUSINESS OPPORTUNITIES—SURPLUS STOCKS—DISCONTINUED MODELS

UNDISPLAYED—RATE PER WORD:
Positions Wanted (full or part-time salaried employment only), 10 cents a word, minimum \$2.00 an insertion, payable in advance. (See ¶ on Box Numbers.)
Positions Vacant and all other classifications, 15 cents a word, minimum charge \$3.00.
Proposals, 40 cents a line an insertion.

INFORMATION:
 Box numbers in care of our New York, Chicago and San Francisco offices count 10 words additional in undisplayed ads. Replies forwarded without extra charge. Discount of 10% if one payment is made in advance for four consecutive insertions of undisplayed ads (not including proposals).

DISPLAYED—RATE PER INCH:
 1 inch \$8.00
 2 to 3 inches 7.80 per inch
 4 to 7 inches 7.60 per inch
Rates for larger spaces, or yearly rates, on request.
 An advertising inch is measured vertically on one column, 3 columns—30 inches—to a page. Radio Retailing

SPECIAL NOTICE:

TO THE RADIO INDUSTRY

Advertising in connection with legitimate offers of surplus stocks and discontinued models of radio merchandise is acceptable in this section of "Radio Retailing."

Extreme care will be exercised by the publishers to prevent the use of advertising in the Searchlight Section to encourage price cutting on current models of merchandise or equipment. Nor will advertising which invites violation of the dealer's contract with the manufacturer be acceptable.

All merchandise offered in the Searchlight Section must be accurately and fully described and must be available on order.

"SEARCHLIGHT"

IS

Opportunity Advertising

—to help you get what you want.

—to help you sell what you no longer need.

Take Advantage Of It

For Every Business Want

See SEARCHLIGHT of this issue

G-7

WANTED Sales Representatives or Manufacturers' Agents

To handle line of Radio Insulators and Accessories made by nationally known manufacturer and sold thru jobbers. Address
 Ra-197, Radio Retailing
 330 West 42d St., New York City

KEEN EMPLOYERS RECOGNIZE WELL TRAINED SERVICE MEN

Many employers insist upon their service men having a background of modern radio servicing methods such as possessed by graduates of America's Oldest Radio School, *Catalog, Dept. RR.*



RCA INSTITUTES, Inc.
 75 Varick St., New York
 1154 Merchandise Mart, Chicago

GENUINE GREBE PARTS

In Stock for all Grebe Sets built prior to 1933. Use only Genuine Grebe Parts in servicing these sets to maintain the original high standard of performance for which they were noted.

Write for Parts Price List

C. I. VERMILYE
 (Former General Factory Manager of
 A. H. Grebe & Co., Inc.)
 137-30 Jamaica Ave. Jamaica, N. Y.

Business Should Be Good ... But Let's Make Sure!

UNUSUAL interest in metal tubes and improved speakers; activity in replacement parts; renewed enthusiasm of dealers and distributors and manufacturers—all have put new vigor into radio merchandising for this fall. After a rather slow spring season every indicator points to an early fall season—and a *lively* one too!

TO help get every one in step, the August issue of *Radio Retailing* will be a "Fall Planning Number."

BRIEF statements from dealers, jobbers and manufacturers as to their plans for securing fall business. . . . Sales ideas suggested by the editors. . . . Regular programs and special features on broadcasting. . . . Suggestions on how to obtain and how

to do service jobs. . . . And much more workable, factual material on how the trade can secure increased sales of radio sets, parts and service.

AS a manufacturer, you undoubtedly have very definite plans of your own. Dealers and distributors want to know about them, as they're all looking for profitable lines to carry. Why not tell the story of your merchandising plans and product plans to all the worthwhile dealers and distributors through the advertising pages of *Radio Retailing*? The men who represent the really profitable portion of your market.

WHAT space shall we reserve for you in the August issue? Forms close July 27th.

RADIO RETAILING
 A McGraw-Hill Publication

"SYLVANIA'S SALES POLICY SURE MAKES SENSE TO ME"



Here's another actual interview...
read what this dealer had to say

● "You bet I push Sylvania tubes, because Sylvania's sales policies make sense to me . . . they seem to talk my language, to see my side of the case.

"I keep Sylvania tubes out front on my shelves, and I give them to my service men for replacements, because we never get any complaints when we put Sylvania tubes in a radio. They're as good tubes as any made . . . and the extra profit I make when I sell them has certainly *sold me* on Sylvania!"

That's about the story . . . dealers, distributors and service men sell Sylvania tubes because they are good, *easy-to-sell* tubes that give them an extra profit.

Would you like to find out more about Sylvania's sales policies? About the extra profit that can be yours by handling Sylvania Tubes? Just write to the Hygrade Sylvania Corporation, Emporium, Pa., and complete information will be sent you without delay.

SYLVANIA

THE SET-TESTED RADIO TUBE

© 1935, H.S.C.

Headquarters for Quality LOW PRICE RADIO SETS

Filling a long needed manufacturing niche in the radio set industry, we announce a line of 4, 5 and 6 tube TRF and superheterodyne receivers. Supplied straight AC and AC-DC—magnetic and dynamic speakers—broadcast band—broadcast, police and amateur bands—broadcast, police, amateur and foreign bands—pilot lights or airplane dials—patent protection—we are *directly* licensed under RCA patents—Exclusive cabinet designs and brand names for quantity buyers—business solicited from *small* as well as *large* accounts.—Export business also solicited—Write at once—get all the details.

FREED MANUFACTURING CO., INC.
127 WEST 17TH ST. NEW YORK, N. Y.
Phone: CHelsea 3-1717 CABLE: RADIOFREED, N.Y.

CORNWICO
"NOISE-MASTER"
ANTENNA

Both broadcast and shortwave reception in all types of locations, are improved noticeably by this splendid CORWICO-engineered antenna system. Licensed under Amy, Aceves & King patents. Use NOISE-MASTER on your very next installation!

CORNISH WIRE CO.
30 Church Street
N. Y. City

INDEX TO ADVERTISERS

This index is published as a convenience to the reader. Every care is taken to make it accurate, but *Radio Retailing* assumes no responsibility for errors or omissions.

Page	Page
Aerovox Corp.	66
American Television Radio Co.	42
Arcturus Radio Tube Co.	70
Atwater-Kent Mfg. Co.	6-7
Central Radio Labs.	62
Cornish Wire Co.	72
Crosley Radio Corp.	Inside Back Cover
Dumont Electric Co., Inc.	70
Electronic Laboratories	62
Emerson Radio & Phono. Corp.	4-5
Eric Resistor Corp.	40
Fada Radio & Elec. Co.	8
Fairbanks Morse Home App., Inc.	19
Freed Mfg. Co.	72
General Electric Co.	20 to 52, Back Cover
General Industries Co.	68
Howard Radio Co.	56
Hygrade Sylvania Co.	72
Kato Engineering Co.	66
Ken-Rad Corp.	42
Muter Co., The.	68
Noblitt-Sparks Ind., Inc.	3
Porcelain Products, Inc.	57
Quam Nichols Co.	53
Radolek Co.	66
RCA Mfg. Co.	Front Cover
Rider, John F.	66
Solar Mfg. Corp.	68
Sparks-Withington Co.	55
Stackpole Carbon Co.	38
Scar Porcelain Co.	42
Stewart-Warner Corp.	Inside Front Cover
Stromberg-Carlson Tele. Mfg. Co.	2
Supreme Instr. Corp.	58
Triplet Elec'l Instr. Co.	62
United American Bosch Corp.	10
United Sound Eng. Co.	70
Universal Microphone Co.	68
Victory Mfg. & Dist. Co.	66
Weston Elec'l Instr. Corp.	60
Zenith Radio Corp.	1

■

SEARCHLIGHT
SECTION

Classified Advertising

Classification	Page
CATALOGS	71
EDUCATIONAL COURSES	71
EMPLOYMENT	71
RADIO STOCKS	71
Vermilye, C. I.	71

McGraw-Hill Publishing Company, Inc., 330 West 42d Street, New York, N. Y. Branch offices: 520 North Michigan Ave., Chicago; 883 Mission St., San Francisco; Aldwych House, Aldwych, London, W. C. 2; Washington; Philadelphia; Cleveland; Detroit; St. Louis; Boston; Greenville, S. C.; James H. McGraw, Chairman of the Board; Malcolm Muir, President; James H. McGraw, Jr., Executive Vice-President; Howard Ehrlich, Vice-President; B. R. Putnam, Treasurer; D. C. McGraw, Secretary. Member A.B.P., Member A.B.C. Printed in U. S. A.

Printed by The Schweinfert Press, N. Y.

**HAVE YOU SEEN THIS BOOK?
"RADIO HISTORY IN THE MAKING"**



**The new
General Electric Dealer Mer-
chandising Plan based on sound
fundamental business principles**

If you believe — as thousands of forward-looking dealers who have read this merchandising plan do — that the time is now ripe to stabilize radio merchandising — we invite you to acquaint yourself with the facts of *Radio History in The Making*.

Here is a presentation which has been provided to every G-E Radio Distributor's salesman. It will make any progressive radio dealer who reads it sit straight up in his chair and realize that the opportunity

of a business lifetime lies before him. *Radio History in The Making* is frankly a blueprint for business building, geared to the requirements of the dealer, fitted to today's changing conditions.

Ask your General Electric Radio Distributor to show you *RADIO HISTORY IN THE MAKING*. Or write to the General Electric Company, Sec. R-117, Merchandise Department, at Bridgeport, Conn., for further details.

GENERAL  ELECTRIC
RADIO

MERCHANDISE DEPARTMENT, GENERAL ELECTRIC COMPANY, BRIDGEPORT, CONNECTICUT



Radio Electric Store

11 West High Street

Phone Main 473

SPRINGFIELD, OHIO

The Crosley Radio Corporation,
Cincinnati, Ohio.

Gentlemen:

We have sold electric refrigerators for the past seven years. We, like other dealers, have learned much from our refrigerator experience. This experience has fully convinced us of the wisdom of centering our efforts on one line; a line that appeals to the widest market. We have found such a line in the Crosley Shelvador, which we have handled for the past two years.

Through the splendid cooperation of the advertising department of the Crosley Corporation in conjunction with WLW, and through special promotion plans we have been able to work out locally, an acceptance for Shelvador has been created throughout this territory, that for the first time in our sales experience with refrigeration, has resulted in real profit.

There is no question that in Springfield, no one can think of an electric refrigerator without thinking of the Shelvador. While, until the past year, we sold other refrigerators along with Shelvador, we found that our sales volume doubled this past year when we went 100% "Shelvador". More than 300 units have been sold in Springfield during the past eight months.

We do not have a large sales organization, but we do have a large "organization" of completely satisfied Shelvador owners. We cooperate with these owners in a substantial way and they cooperate with us in getting new sales. The trouble-free operation of the Shelvador is a decided asset in maintaining this cooperation. Our service department shows that the number of service calls has been cut in half since we have handled only Shelvador. We have never found it necessary to canvass for Shelvador sales. Our owners send us more prospects than we can call on.

All of this is convincing evidence of the merits, the salability, and the satisfactory performance of this remarkable refrigerator. There is no question that, both from the dealer's standpoint and the owner's standpoint, Shelvador is the most desirable and satisfactory electric refrigerator on the market today.

Sincerely yours,

THE RADIO ELECTRIC STORE

per

V. J. Coughenour

VJC-S

It takes a RIFLE for big game. Specialty dealers of the widest experience agree that it is better to concentrate on one line than to scatter over several.

When you handle the Crosley Shelvador you need no other refrigerator line. Shelvador (in 3 types—Table Shelvador, Shelvador, and Tri-Shelvador) and 15 models ranging in price from \$79.50 to \$219.50 (delivered, installed...one year free service) meets every requirement from smallest home or summer cottage to largest mansions. Each group represents a distinct and unique value never before approached; each has features found nowhere else.

By buying from one source, by centering your efforts on one line, by pushing the exclusive Shelvador feature, by identifying yourself with the nation-wide Crosley Shelvador advertising campaign in dozens of national publications and over the radio... obviously you can go farther, make more money. The sooner you switch to 100% Shelvador, the bigger will be your year's volume.

THE CROSLEY RADIO CORPORATION - CINCINNATI

Home of "the Nation's Station"—WLW—500,000 watts—most powerful in the world—70 on your dial

POWEL CROSLEY, Jr., President